

Thank you for your patronage.

This CD was purchased from @home backup. If it was purchased or obtained by any other means, you have illegally obtained this CD and are in violation of its copyrights.

Report copyright violations to: @home backup
Attn: Manual Backups
2902 Grasmere St.
Garland, TX 75040

Unauthorized duplication or distribution is strictly prohibited.

 HONDA MOTOR CO., LTD.

31HB5600
00X31HB5-6000

英 M700085103
PRINTED IN JAPAN

ATC200X

**1986
HONDA**



**OWNER'S
MANUAL**

IMPORTANT NOTICE

● **OPERATOR ONLY. NO PASSENGERS.**

This vehicle is designed and constructed as an operator-only model. The vehicle load limit and seating configuration do not safely permit the carrying of a passenger.

● **FOR OFF-ROAD USE ONLY.**

This vehicle is designed and manufactured for off-road use only. It conforms with US EPA Noise Emission regulations, but does not conform to Federal Motor Vehicle Safety Standards or US EPA Exhaust Emission regulations, and operation on public streets, roads, or highways is illegal. The vehicle is equipped with a USDA approved spark arrester. Obey local laws and regulations.

● **READ THIS OWNER'S MANUAL CAREFULLY**

Pay special attention to statements preceded by the following words:

WARNING

Indicates a strong possibility of severe personal injury or loss of life if instructions are not followed.

CAUTION:

Indicates a possibility of personal injury or equipment damage if instructions are not followed.

NOTE: Gives helpful information.

This manual should be considered a permanent part of the ATC and should remain with the ATC when resold.



All information in this publication is based on the latest product information available at the time of approval for printing. HONDA MOTOR CO., LTD. reserves the right to make changes at any time without notice and without incurring any obligation.

No part of this publication may be reproduced without written permission.

////// PREFACE //////////////////////////////////////

This booklet is your guide to the basic operation and proper maintenance of your new Honda ATC200X. Please take the time to read it carefully. Details necessary for riding the Honda ATC are given to acquaint the new owner with special riding techniques to be learned. When service is required, remember that your Honda dealer knows your vehicle best. If you have the required mechanical "know-how" and tools, your dealer can supply you with an official Honda Shop Manual to help you perform many maintenance and repair tasks.

Thank you for selecting a Honda. We wish you continued riding pleasure in the miles ahead.

WARNING

** The ATC 200X is a high performance machine, based on the latest technology. It is intended for use by experienced riders only. Although it is a recreational vehicle, it is definitely NOT a toy.*

NOTE:

* When reference to the right or left side of the vehicle is made, it is determined from the rider's view.

////// CONTENTS //////////////////////////////////////

	Page		Page
ATC SAFETY	1	Oil Filter Rotor	40
DESCRIPTION	3	Fuel Strainer Screen	41
Parts Location	3	Valve Clearance	42
Serial Numbers	5	Carburetor Idle Speed	44
Parts Function	6	High Altitude	45
Fuel	11	Air Cleaner Case Drain Tube	46
Engine Oil	14	Spark Plug	47
Tires	16	Air Cleaner	48
Front Suspension	18	Clutch System	49
Rear Suspension	19	Brakes	51
OPERATION	21	Throttle Operation	55
Pre-ride Inspection	21	Drive Chain	56
Starting the Engine	22	Spark Arrester	58
Break-in	25	STORAGE	59
Riding	26	TRANSPORTING	60
Parking	34	NOISE EMISSION CONTROL SYSTEM	64
MAINTENANCE	35	SPECIFICATIONS	65
Maintenance Schedule	35	WIRING DIAGRAM	66
Tool Kit	37	WARRANTY SERVICE	68
Engine Oil	38		
Engine Oil Strainer Screen	39		

////////////////////// ATC SAFETY ////////////////////////

Read these WARNING INFORMATION before you ride!

▲ WARNING

- OPERATOR USE ONLY. PASSENGERS PROHIBITED.
- THIS IS A HIGH PERFORMANCE VEHICLE INTENDED FOR USE ONLY BY HIGHLY EXPERIENCED RIDERS.
- ADULT SUPERVISION AND INSTRUCTION IS REQUIRED. NOT RECOMMENDED FOR CHILDREN UNDER 14.
- THIS VEHICLE IS DESIGNED AND MANUFACTURED FOR OFF-ROAD USE ONLY. OPERATION ON PUBLIC STREETS, ROADS OR HIGHWAYS IS ILLEGAL.
- ALWAYS WEAR A HELMET.
- DO NOT OPERATE THIS VEHICLE AFTER CONSUMING ALCOHOL OR DRUGS.
- GASOLINE IS FLAMMABLE. SHUT OFF ENGINE. AVOID SPARKS AND OPEN FLAME WHEN REFUELING.
- READ OWNER'S MANUAL CAREFULLY BEFORE RIDING. KEEP OWNER'S MANUAL WITH VEHICLE.

▲ WARNING
OPERATOR ONLY
NO PASSENGERS

▼ IMPORTANT INFORMATION

- COLD TIRE PRESSURE:
FRONT 3.5 ± 0.4 psi 0.25 ± 0.03 kg/cm²
REAR 2.5 ± 0.4 psi 0.17 ± 0.03 kg/cm²
- VEHICLE CAPACITY LOAD: 270 lbs (120 kg)
- USE ONLY TIRES SPECIFIED IN OWNER'S MANUAL.

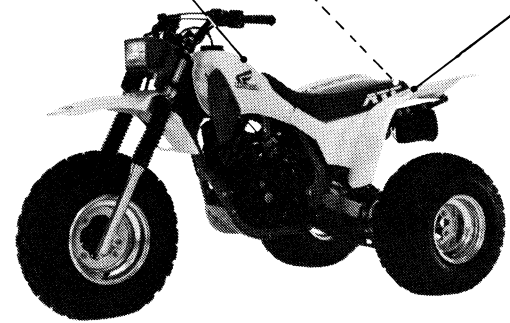

A
T
C

S
A
F
E
T
Y

WARNING

- * *ATC riding requires special efforts on your part to ensure your safety. Know these requirements before you ride.*

SAFE RIDING RULES

- * Always make a pre-ride inspection (page 21) before you ride the ATC. You may prevent an accident or equipment damage.
- * Always obey local off-road riding laws and regulations.
- * Obtain permission to ride on private property. Avoid posted areas and obey "no trespassing" signs.
- * Know the terrain on which you are riding. If you are not familiar with the terrain, ride cautiously. Hidden rocks, holes or ravines could spell disaster.
- * Your ability to operate safely is largely dependent upon your proper judgement in operating the machine.
- * Alcohol, drugs and ATC's don't mix. Even the smallest amount of alcohol can impair your ability to operate your ATC safely. Likewise, drugs, even if prescribed by a physician, can be dangerous while operating an ATC. Consult your doctor to be sure it is safe to operate a motor vehicle after taking medication.

ATC SAFETY

PROTECTIVE APPAREL

- * Always wear a helmet. You should also wear a face shield or goggles, boots, gloves and protective clothing.
- * The exhaust system becomes very hot during operation and it remains hot after operation. Never touch any part of the hot exhaust system. Wear clothing that fully covers your legs.

MODIFICATIONS

- * Modification of the ATC, or removal of original equipment may render the vehicle unsafe or illegal.
- * Spark arresters and mufflers are required in most areas. Don't modify your exhaust system. Remember that excessive noise bothers everyone and creates a bad image for off-road vehicles.

DESCRIPTION

PARTS LOCATION

- (1) Fuel tank cap
- (2) Throttle lever
- (3) Front brake lever
- (4) Helmet holder
- (5) Kick starter pedal
- (6) Footpeg
- (7) Rear brake pedal
- (8) Engine oil dipstick

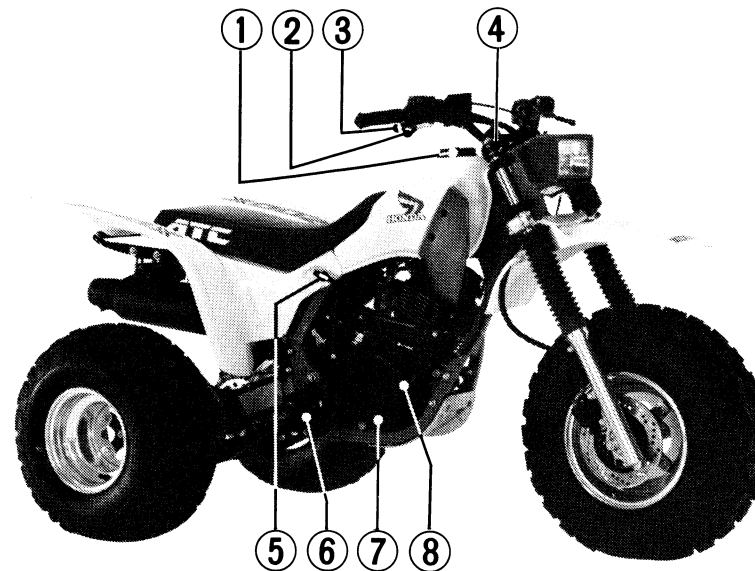

- (9) Clutch lever/parking brake arm assy
- (10) Headlight switch
- (11) Engine stop switch
- (12) Fuel valve
- (13) Choke lever
- (14) Gearshift pedal

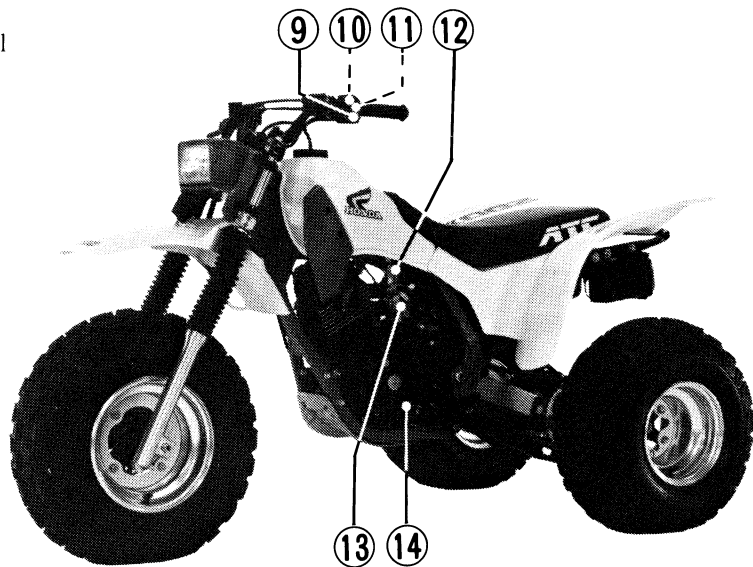

SERIAL NUMBERS

The frame and engine serial numbers are required by your dealer when ordering replacement parts. Record the numbers here for your reference.

FRAME NO. _____

The frame serial number (1) is stamped on the right side of the steering head. The engine serial number (2) is stamped on the crankcase just above the left foot peg.

ENGINE NO. _____

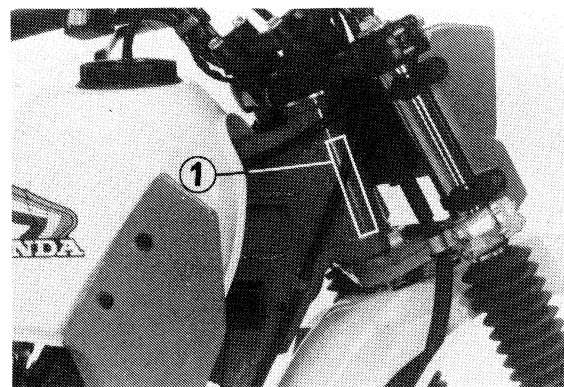

(1) Frame serial number

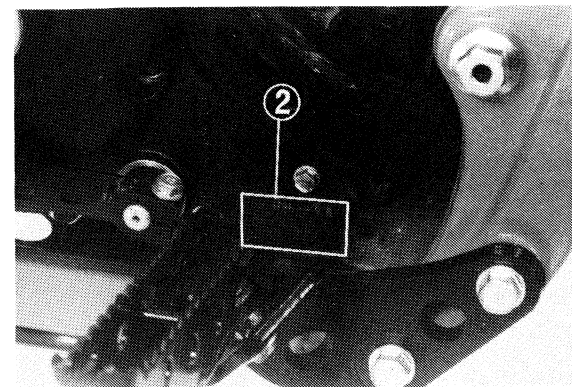

(2) Engine serial number

PARTS FUNCTION

Engine Stop Switch

The three position engine stop switch (1) is under the headlight switch. When the switch is in the RUN position, the engine will operate. When the switch is in either OFF position, the engine will not operate. This switch can be used as a safety or emergency switch.

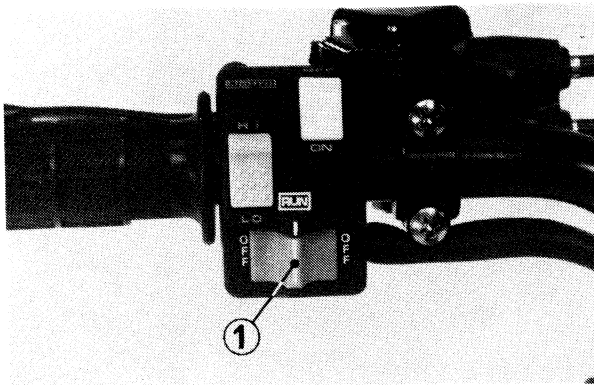

(1) Engine stop switch

Headlight switch

The headlight switch (2) is above the engine stop switch and turns the headlight ON or OFF.

Headlight dimmer switch

With the headlight switch (2) ON, use the dimmer switch (3) to select Hi for high beam or Lo for low beam.

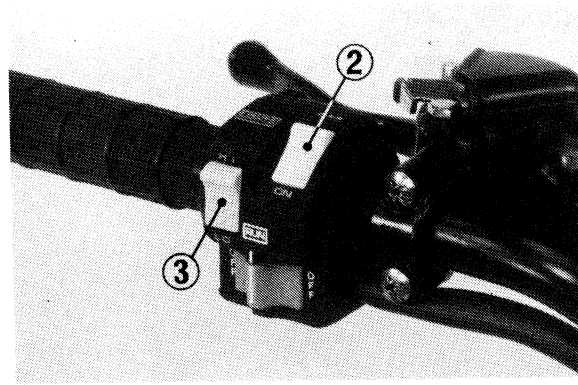

(2) Headlight switch (3) Headlight dimmer switch

Parking Brake

The clutch lever also functions as the parking brake lever.

To apply the parking brake, push down the parking brake arm pin (2), squeeze the clutch lever (1) and lock it with the lock (3). Always apply the parking brake when parking the ATC or starting the engine. To release the parking brake, squeeze the clutch lever (1) so the lock (3) automatically retracts.

NOTE:

* Use of the parking brake in freezing weather may cause the rear brake to freeze in the locked position.

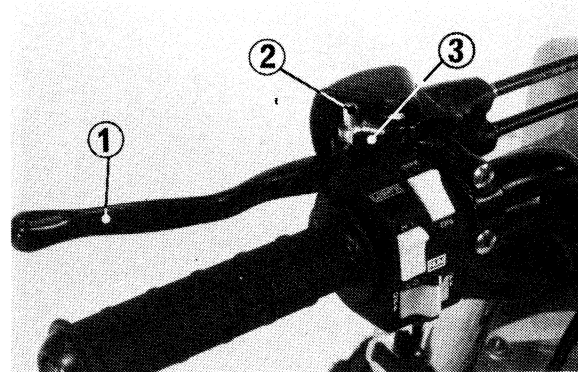

(1) Clutch lever (2) Parking brake arm pin (3) Lock

Front Brake

The front brake lever (1) is on the right handlebar. To stop the ATC, apply the front and rear brakes evenly, with the front wheel aimed straight ahead.

Throttle Lever

The throttle lever (2) is next to the right handlebar grip and is operated by the rider's thumb. Pressing the lever forward opens the throttle. When the lever is released, spring tension closes the throttle automatically.

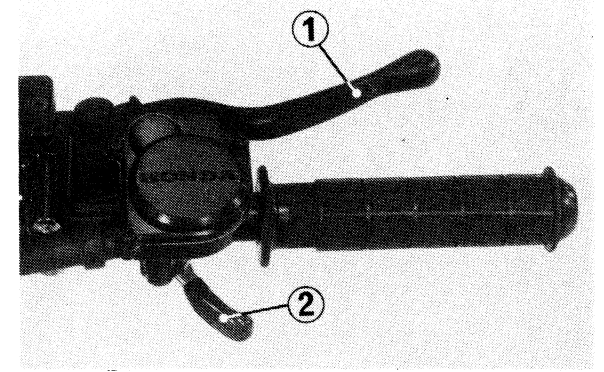

(1) Front brake lever (2) Throttle lever

Rear Brake

The rear brake pedal (1) is near the right footpeg.

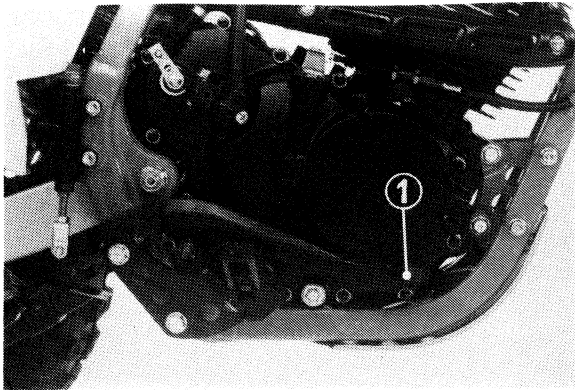

(1) Rear brake pedal

Gearshift Pedal

The gearshift pedal (1) is near the left footpeg. Depress the pedal to shift to a lower gear and raise the pedal to shift to a higher gear.

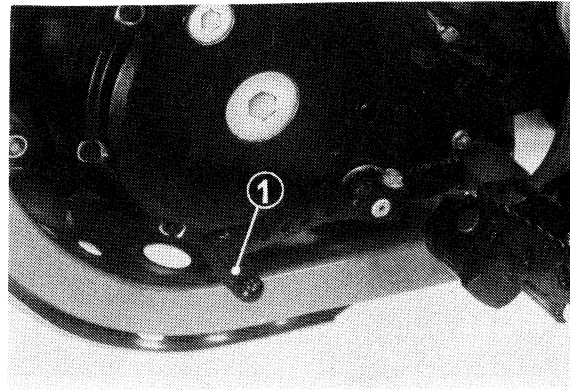

(1) Gearshift pedal

Choke Lever

The choke lever (1) is on the left side of the carburetor.

Raising the choke lever will close the choke valve. When the lever is raised, the carburetor will deliver a rich fuel mixture for starting the engine when cold. Lower the lever to open the choke valve as the engine attains normal operating temperature.

To restart a warm engine, it is not necessary to use the choke.



(1) Choke lever

Helmet Holder

The helmet holder (1) is located on the right side of the fork bridge. To use the helmet holder, hang your helmet on the holder hook (2).

WARNING

* *Do not operate the ATC with a helmet attached to the holder. The helmet holder is designed for use while parked.*

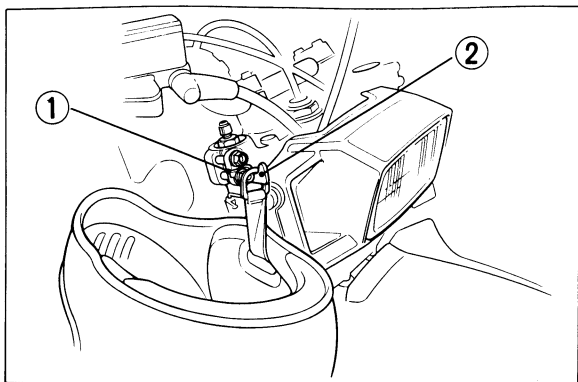

(1) Helmet holder (2) Hook

Owner's Manual Compartment

This owner's manual should be stored in the lower compartment (1) in the tool box. When washing your ATC or riding through water, be careful not to flood this area with water.

NOTE:

* The air pressure gauge should be stored in this owner's manual compartment.

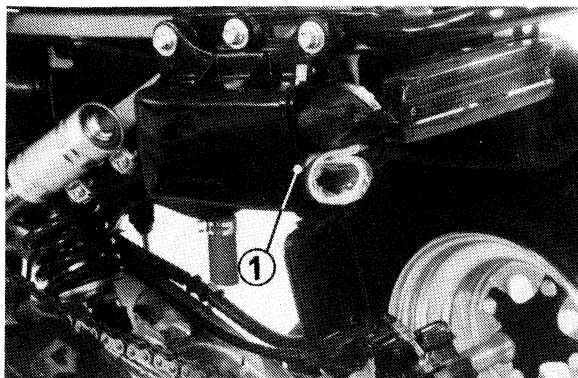

(1) Owner's manual compartment

FUEL

Fuel Valve

The three way fuel valve (1) is on the left side of the fuel tank.

OFF

When the fuel valve is in the OFF position, fuel cannot flow from the tank to the carburetor. Turn the valve off whenever the ATC is not in use.

ON

When the fuel valve is in the ON position, fuel will flow from the main fuel supply to the carburetor.

RES

When the fuel valve is in the RES position, fuel will flow from the reserve fuel supply to the carburetor. Use the reserve fuel only when the main supply is gone. Refill the tank as soon as possible after switching to RES. The reserve fuel supply is 1.5 l (0.40 US gal).

NOTE:

* Do not operate the ATC with the fuel valve in the RES position after refueling. You may run out of fuel, with no reserve.

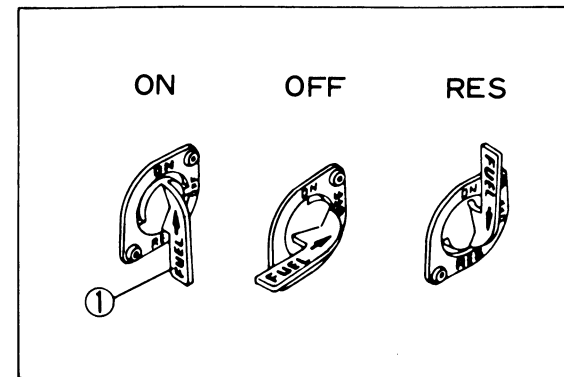

(1) Fuel valve

Fuel Tank

Fuel tank capacity is 10.5 l (2.78 US gal) including 1.5 l (0.40 US gal) in the reserve supply. To open the fuel tank cap (1), pull out the breather tube (2) from the steering stem nut. Then turn the fuel tank cap counterclockwise.

Automotive gasoline with a pump octane number (R+M) of 86 or higher, or research octane number of 91 or higher may be used.

If knocking or pinging occurs try a different brand of gasoline or a higher octane grade.

CAUTION:

* *Should knocking or pinging persist while holding a steady speed on a level road, try changing brands of gasoline. If knocking or pinging still persists, consult your Honda dealer.*

After refueling, be sure to tighten the fuel tank cap firmly by turning clockwise until the arrow (3) on the cap faces forward. Insert the breather tube into the steering nut.



- * *Gasoline is extremely flammable and is explosive under certain conditions. Refuel in a well ventilated area with the engine stopped. Do not smoke or allow open flames or sparks in the area where the vehicle is refueled or where gasoline is stored.*
- * *Do not overfill the tank (there should be no fuel in the filler neck). After refueling, make sure the tank cap is closed securely.*
- * *Avoid repeated or prolonged contact with skin or breathing of vapor. KEEP OUT OF REACH OF CHILDREN.*

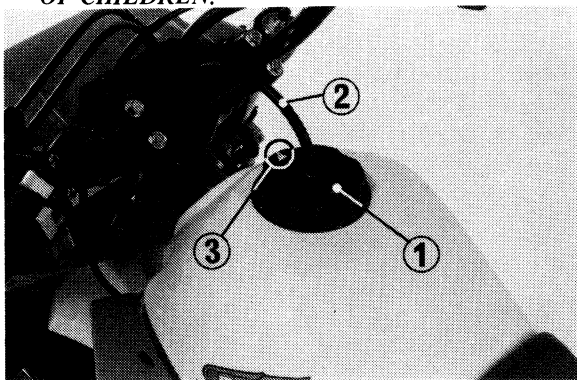

(1) Fuel tank cap (3) Arrow
(2) Breather tube

Gasolines Containing Alcohol

If you decide to use a gasoline containing alcohol (“gasohol”), be sure its octane rating is at least as high as that recommended. There are two types of “gasohol”: that containing ethanol, and that containing methanol. Do not use gasohol that contains more than 10% ethanol. Do not use gasoline containing methanol (methyl or wood alcohol) that does not also contain cosolvents and corrosion inhibitors for methanol. Never use gasoline containing more than 5% methanol, even if it has cosolvents and corrosion inhibitors.

NOTE:

- * Fuel system damage or vehicle performance problems resulting from the use of such fuels is not covered under new ATV Warranties. Honda cannot endorse the use of fuels containing methanol since evidence of their suitability is as yet incomplete.
- * Before purchasing fuel from an unfamiliar station, try to confirm whether the fuel contains alcohol, and to what percentage. If you notice any undesirable operating symptoms after using a gasoline that contains alcohol, or one that you think contains alcohol, switch to a higher octane gasoline as recommended.

ENGINE OIL

Engine Oil Level Check

Check the engine oil level each day before operating the ATC.

The oil filler cap (1) is on the right crankcase cover and contains a dipstick for measuring the oil level. The oil level must be maintained between the upper (2) and lower (3) level marks on the dipstick.

1. With the ATC on level ground, remove the oil filler cap/dipstick and wipe it clean.
2. Reinsert the dipstick without screwing it in. Remove the oil filler cap/dipstick again and check the oil level.
3. If required, add the specified oil up to the upper level mark. Do not overfill.
4. Reinstall the filler cap/dipstick.

CAUTION:

* *Running the engine with insufficient oil can cause serious engine damage.*

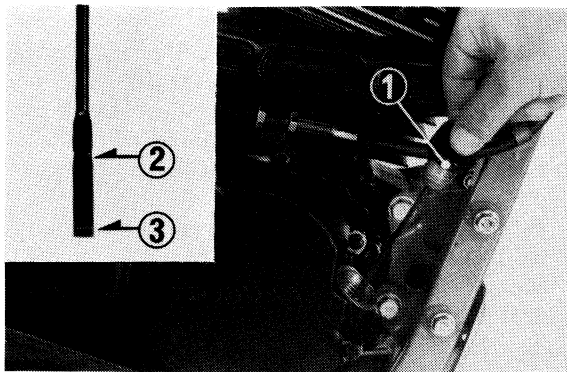

(1) Oil filler cap/dipstick (3) Lower level mark
(2) Upper level mark

Engine Oil Recommendation

USE HONDA 4-STROKE OIL OR AN EQUIVALENT.

Use only high detergent, premium quality motor oil certified to meet or exceed US automobile manufacturers' requirements for Service Classification SE or SF.

Motor oils intended for Service SE or SF will show this designation on the container. The use of special oil additives is unnecessary and will only increase operating expenses.

CAUTION:

* *Engine oil is a major factor affecting the performance and service life of the engine. Non-detergent, vegetable, or castor based racing oils, are not recommended.*

Recommended Oil Viscosity:

SAE 10W-40

Other viscosities shown in the chart below may be used when the average temperature in your riding area is within the indicated range.

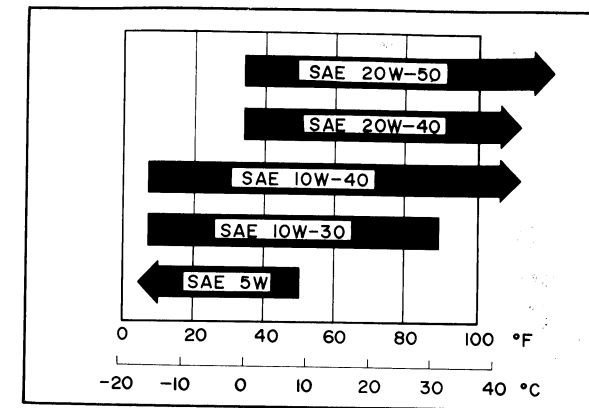

TIRES

The ATC200X is equipped with low pressure tubeless tires to promote comfortable riding. Although the tires are designed specifically for vigorous off-road use, they are not immune to punctures. Always select your riding area with care.

WARNING

* *The ATC is not designed to be ridden on paved surfaces. Handling and control will be severely affected.*

Check tire pressure frequently with the air pressure gauge supplied with this ATC.

For normal use, the tires should be inflated to the recommended pressure. A manually operated tire pump should be used rather than the high pressure systems found in service stations. This will minimize the possibility of tire damage from overinflation.

NOTE:

* Tire pressure should be checked when the tires are "cold," before you ride.

If no air pressure gauge is available to accurately measure a recommended pressure, this value can be estimated by measuring the circumference of the tires with a measuring tape. When inflated to the recommended pressure, the maximum tire circumference measured over the tread ribs will be approximately standard tire circumference. The relationship between

tire pressure and actual circumference varies slightly with factors of wear and stretching that occur through use.

	Front	Rear
TIRE SIZE	23.5x8.0-11	22x10-9
TIRE BRAND	OHTSU PV101	OHTSU PV701
Recommended pressure	3.5 psi (25 kPa, 0.25 kg/cm ²)	2.5 psi (17 kPa, 0.17 kg/cm ²)
Standard tire circumference	1890 mm (74.4 in)	1720 mm (67.7 in)
Max. pressure	3.9 psi (28 kPa, 0.28 kg/cm ²)	2.9 psi (20 kPa, 0.20 kg/cm ²)
Min. pressure	3.1 psi (22 kPa, 0.22 kg/cm ²)	2.1 psi (14 kPa, 0.14 kg/cm ²)

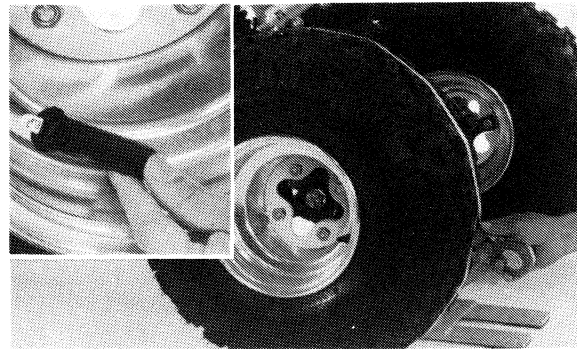

WARNING

* *Maintain proper tire air pressure. Improperly inflated tires may adversely affect maneuverability and may cause loss of control.*

If you have a flat tire, use the plug method to make temporary repairs. The plug method is the same as that for conventional tubeless tires. A plug type repair kit, which is available at most auto part stores or service stations, provides a plug, an installation tool, tire cement, and an instruction sheet. Follow the instructions provided in the repair kit to make a temporary repair until the tire can be permanently repaired by the cold patch method. Any tire which cannot be repaired by the plug method should be replaced.

Whenever the ATC is to be operated far from service facilities or available transportation, we recommend that the rider carry a tire pump and a suitable repair kit.

Emergency Puncture Repairs

If you have a flat tire, and a plug type repair kit is not available, use one of the following methods to make temporary repairs: Stuff a narrow strip of cloth kneaded with chewing gum into the hole or plug the hole with a nail or screw.

NOTE:

* Do not use soapy water, oil or other such substances when installing a tire on the rim.

FRONT SUSPENSION

The front suspension system uses air assisted front forks. The forks may be adjusted for the rider's weight and riding conditions by adjusting the air pressure.

Air pressure adjustment

The standard front fork air pressure setting is for normal loads and riding conditions. The air pressure can be increased for heavier loads and rougher riding conditions.

Check and adjust air pressure when the fork tubes are cold and with the front wheel off the ground, for accurate pressure readings.

1. Place a support under the engine to raise the front wheel off the ground.
2. Remove the air valve caps (1) and check the air pressure with the pressure gauge.

Standard air pressure: 0 psi (0 kPa, 0 kg/cm²)

3. To increase the air pressure, add air with a bicycle air pump. To decrease air pressure, depress the valve core.

Some pressure will be lost when using the gauge. Determine the amount of loss and compensate accordingly.

Also, be sure that the air pressure in both fork tubes is equal.

NOTE:

- * Use of more than 10 psi (70 kPa, 0.7 kg/cm²) is not recommended because fork action becomes very stiff.



(1) Air valve caps

REAR SUSPENSION

The ATC200X has a shock absorber with two adjustments for the rider's weight and riding conditions. The spring adjuster nut (1) adjusts spring preload for changes in the rider's weight.

The rebound damping adjuster (3) adjusts damping from soft to firm to provide the desired ride with changes in the rider's weight and riding conditions.

CAUTION:

- * *Make sure the engine is off and the parking brake is applied before adjusting the rear suspension.*

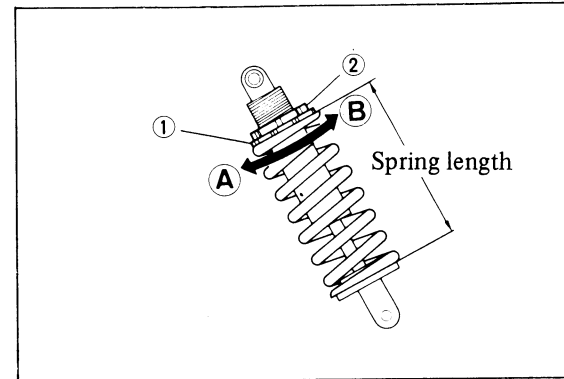

- (1) Adjuster nut (A) Increase
(2) Lock nut (B) Decrease

To adjust spring preload:

1. Remove the seat/rear fender by sliding the lever.
2. Place a support under the engine to raise the rear wheel off the ground.
3. Measure the spring length.
Standard: 190 mm (7.48 in)
Minimum: 185.5 mm (7.30 in)
Maximum: 191.5 mm (7.53 in)
4. To adjust preload, loosen the lock nut (2) with a pin spanner and turn the adjuster nut (1).

NOTE:

- * An optional pin spanner for adjusting the rear suspension is available at your authorized Honda dealer.

5. Tighten the lock nut and measure the spring length again, make sure the adjustment is within the minimum or maximum allowable adjustment length. Reinstall the seat /rear fender, making sure they are securely attached.

To adjust rebound damping:

There are four detent rebound damping adjustment positions. The damping adjuster (4) is located at the bottom of the shock and is marked for each adjustment position.

Slide the protective rubber (3) down.

Turn the damping adjuster (4) by hand to the desired adjustment.

Adjuster Position	
Soft	1
↑	2
↓	3
Firm	4

NOTE:

- * Be sure the damping adjuster is not between positions but is located in a detent.

WARNING

- * *The rear shock absorber damper body, reservoir and hose contain pressurized nitrogen at (284 psi, 1961 kPa, 20 kg/cm²). Do not attempt to disassemble the shock body.*
- * *Do not disconnect the reservoir hose, or disassemble or refill the reservoir.*
- * *Keep fire and heat away from the shock and its reservoir.*
- * *If you replace the shock absorber, take the old unit to your authorized Honda dealer for disposal.*

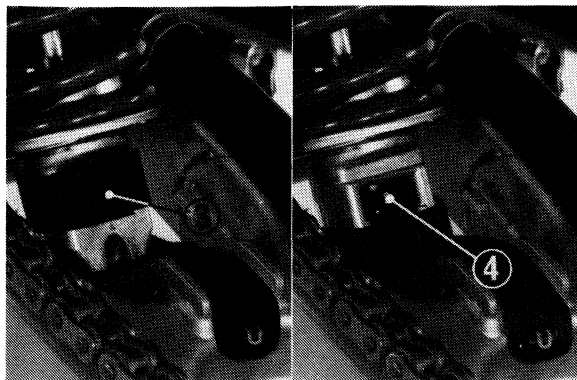

(3) Protective rubber

(4) Damping adjuster

OPERATION

PRE-RIDE INSPECTION

WARNING

- * *If the Pre-ride Inspection is not performed, serious damage or an accident may result.*

Inspect your ATC every day before you ride it. The items listed here will only take a few minutes to check, and in the long run they can save time expense and possibly your life.

1. Engine oil level—add engine oil if required (page 14). Check for leaks.
2. Fuel level—fill the fuel tank when necessary (page 12). Check for leaks.
3. Brakes—check operation and fluid level (page 51–52).
4. Tires—check condition and pressure (page 16).
5. Drive chain—check condition (particularly the master link) and slack (page 56). If necessary, adjust and lubricate (page 56).
6. Throttle—check for smooth opening and closing in all steering positions (page 55).
7. Headlight switch—check for proper function (page 6).
8. Engine stop switch—check for proper function (page 6).

9. Nuts, bolts, fasteners—check wheels to see that axle nuts are tightened and secured by cotter pins.

Check the security of all other nuts, bolts and fasteners.

Correct any discrepancy before you ride. Contact your authorized Honda dealer for assistance if you cannot correct the problem.

STARTING THE ENGINE

WARNING

- * *Never run the engine in a closed area. The exhaust contains poisonous carbon monoxide gas.*
- * *Do not try to start the engine with the transmission in gear. You may injure yourself or damage the vehicle.*

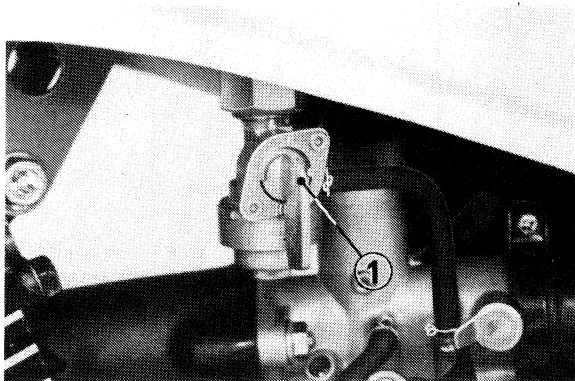

(1) Fuel valve

Preparation

1. Select a level surface and apply the parking brake ON.
2. Turn the fuel valve (1) to ON.
3. Make sure the engine stop switch (2) is at RUN.

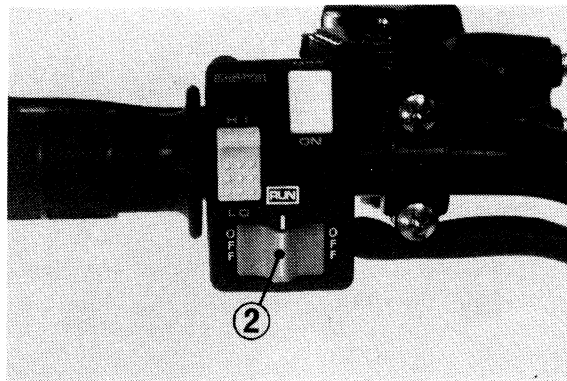

(2) Engine stop switch

Starting Procedure (after Preparation)

To restart a warm engine, follow the procedure for High Air Temperature.

Normal Air Temperature

10°C–35°C (50°F–95°F)

1. Raise the choke lever (3) to the Fully Closed position (A).
2. Open the throttle slightly. (1/8–1/4)
3. Operate the kick starter (5) with a rapid, continuous motion.

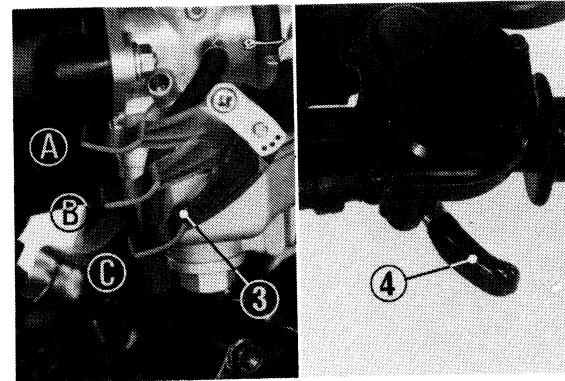

(3) Choke lever

(4) Throttle

4. Immediately after the engine starts, push the choke lever down to the detent position (B).
5. About a half minute after the engine starts, push the choke lever down all the way to Fully Open (C).
6. If idling is unstable, open the throttle slightly.

High Air Temperature

35°C (95°F) or above

1. Do not use the choke.
2. Open the throttle slightly (0–1/8).
3. Start the engine (See Step 3 under Normal Air Temperature).

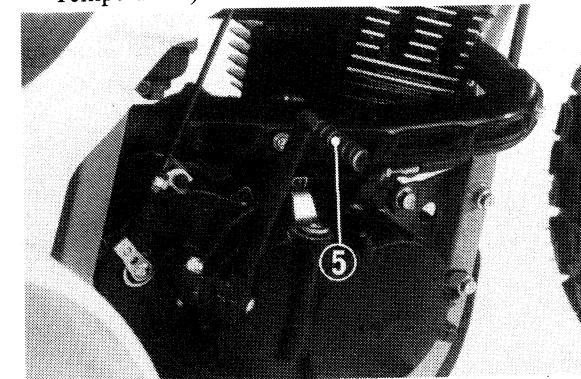

(5) Kick starter

Low Air Temperature

10°C (50°F) or below

1. Follow steps 1–4 under Normal Air Temperature.
2. Warm up the engine by opening and closing the throttle slightly (0–1/8).
3. Continue warming up the engine until it will idle smoothly with the choke lever pushed down all the way to Fully Open (C).

CAUTION:

- * *Extended use of the choke may impair piston and cylinder wall lubrication.*
- * *Do not race the engine during the warm-up period. Racing a cold engine wastes fuel and increases engine wear.*

Flooded Engine

If the engine does not start after several attempts, it may have become flooded with excess fuel. To clear the engine, turn the ignition switch off, push the choke lever down all the way to Fully Open, hold the throttle fully open, and operate the kick starter several times. When the engine is cleared, turn the ignition switch on and repeat the normal starting procedure, but do not use the choke.

BREAK-IN

During the first few days of riding, operate your new ATC200X so that the engine neither pulls laboriously nor approaches maximum rpm in any gear. Avoid full throttle operation, and select your gears to spare the engine undue stress. A careful break-in during initial operation will measurably extend the service life of the engine.

RIDING

WARNING

- * *Review ATC Safety (page 1–2) before you ride.*
- * *Avoid “wheelies” and “jumping” as they may cause loss of control.*
- * *Ride with both feet on the footpegs at all times. If your feet are off the footpegs and touch the ground while the ATC is moving, they may come in contact with the rear wheels, causing injury.*
- * *The ATC is not designed to be ridden on paved surfaces. Handling and control will be severely affected.*

Under normal riding conditions it is not necessary or desirable to touch the ground for balance.

For your initial riding practice, select a safe area free of obstacles and with an even surface.

1. After the engine has been warmed up, release the parking brake. The ATC is ready for riding.
2. While the engine is idling, pull in the clutch lever and depress the gearshift pedal to shift into 1st (low) gear.
3. Gradually release the clutch lever as you increase engine speed by opening the throttle.
4. When the speed increases, close the throttle, pull in the clutch lever, and shift to 2nd gear by raising the gearshift pedal.

5. This sequence is repeated to progressively shift up to 3rd, 4th, 5th and 6th (top) gear.

CAUTION:

- * *Do not shift gears without disengaging the clutch and closing the throttle. The engine and drive train could be damaged by overspeed and shock.*
- * *Do not tow the vehicle or coast for long distances while the engine is OFF. The transmission will not be properly lubricated and damage may result.*

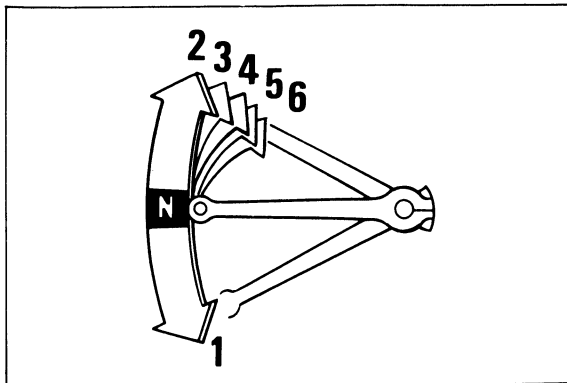

Shifting pattern

Turning Maneuvers

For better traction in off-road use, the ATC has been fitted with a rear axle which drives both rear wheels equally at all times.

When negotiating a turn, the wheel on the outside of the turn must travel a wider radius, and thus a greater distance, than the inside wheel. As the rear axle does not permit a differing rate of wheel rotation, it is not enough to merely steer the ATC into a turn. The new rider must learn to shift his weight and control the throttle to allow the rear tires to negotiate the turn. This is the primary technique to be mastered in riding the Honda ATC.

Practice turning the ATC at slow, constant speeds. For your initial riding practice, operate the ATC in low gear.

Defer higher speeds until you are confident of your abilities.

Steer in the direction of the turn, and lean your body to the inside of the turn, while supporting your weight on the outer footpeg. Use the throttle to maintain power throughout the turn.

This technique allows the ATC to lean slightly toward the outside, altering the balance of traction between the rear wheels sufficiently to allow them to negotiate the turn.

Once this technique is learned, turning maneuvers can be performed within a relatively small area.

Support your weight on outer footpeg.

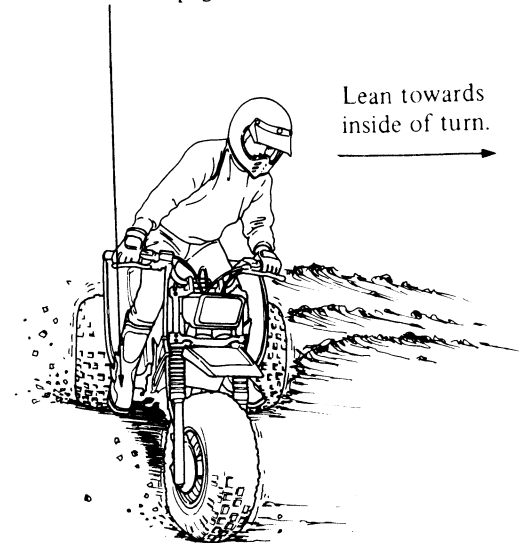

Lean towards inside of turn.

Incorrect turning techniques may cause the front wheel to slide straight ahead when steered without affecting the ATC's direction of travel. If this should occur, close the throttle and come to a stop. Then continue practicing the technique outlined on the preceding page.

If the front wheel tends to skid in mud or snow, you may be able to improve control under these conditions by leaning forward, transferring additional weight to the front wheel.

If the rear wheels inadvertently skid sideways, correct your slide by steering in the direction of the skid, if you have room to perform this maneuver safely. Avoid braking or accelerating until you have directional control.

To avoid skids while traveling on slippery terrain, the rider must exercise a high degree of caution. Controlled skids and spins, when performed safely, add to the sport the rider can enjoy. However, as skidding maneuvers are inherently more hazardous than those performed under full traction, we must caution the rider to first master the basic techniques of handling before practicing any skidding maneuver.

Surface composition is, of course, a major factor affecting skidding capability. It is obviously easier to slide on packed snow than in deep sand. Surfaces with extremely low or extremely high coefficients of friction must not be used for skidding maneuvers. It is dangerous to skid on ice, because you may lose all directional control, and it is dangerous to skid on pavement, because you may regain traction suddenly and unexpectedly, which can cause you to lose your balance and overturn.



Climbing Hills

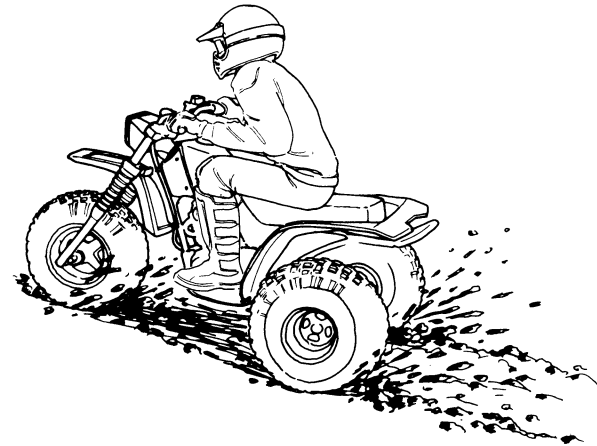

Practice climbing on evenly surfaced slopes of less than 20°. The ATC's capability in climbing hills or traversing any specific terrain is dependent upon rider skill. As you gain experience in handling the ATC, and learn the hazards to be encountered and your own limitations, you may then proceed to ride more challenging terrain. However, you must first be able to discern and avoid any hill or hazard that would cause the ATC to overturn.

The riding technique for hill climbing involves transferring your weight toward the front wheel to keep it in contact with the ground. This may be done by leaning forward, or for greater weight transference, by standing on the footpegs and leaning forward.

Take a running start, in the appropriate gear and speed for the ascent, and climb at a steady rate of speed.

WARNING

- * *Do not apply power suddenly by opening the throttle or changing gears while ascending a hill or the front wheel may rise from the ground. If the front wheel lifts, rider control will be lessened and the ATC may overturn backward.*
- * *Hill should not be crested at high speed. Once over the top of the hill, you may lose control or be thrown from the ATC.*

If you should find that you have incorrectly estimated climbing capability and lack the power or traction to continue the ascent, then turn the ATC around if space permits, while you still have the forward speed to do so and descend. Avoid stalling part way up a hill, as maneuvering will then become more difficult.

WARNING

* Before attempting a turn on a hillside, the rider should first master turning technique on level ground.

If you do lose all forward speed, and can neither continue uphill nor maneuver the ATC under its own power, dismount and physically turn the machine around. If it cannot be turned and must be backed down, first shift the transmission into neutral and very carefully back the ATC down, slowing it by use of both brakes. However, we strongly recommend that the rider turn the ATC around rather than back it downhill.

WARNING

* To avoid overturning, the rider must exercise a high degree of caution when dismounting or moving the ATC on a hillside.

* Applying only the rear brake or engaging the transmission, while rolling backward downhill can easily cause the ATC to overturn and fall on the rider.



Descending Hills

It is usually advisable to descend hills with the ATC pointed directly downhill, avoiding angles that would cause the vehicle to lean sharply to one side. As you approach the point of descent, stop and survey the terrain below. Never ride headlong past your limit of visibility. When you have picked a safe path of descent, shift the transmission into low gear and descend slowly with the throttle closed. Sit back on the seat, with arms extended and braced on the handlebars.

When descending sand dunes, we recommend that the rider intermittently apply both brakes.

Braking effectiveness is, of course, reduced while descending any incline with a loose surface.

CAUTION:

* Do not lock the brakes or you may lose control.

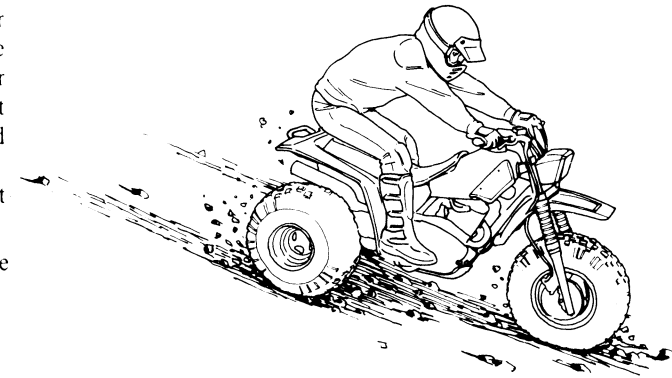

Traversing Slopes

When riding across a slope at right angles to the incline of the hill, lean your body uphill to maintain balance and stability. On a loose surface such as sand, it may become necessary to steer slightly uphill in order to maintain your course of travel.

WARNING

- * *Balance is more precarious while the ATC is tilted to one side. Avoid traversing slopes where there is slippery or difficult terrain.*



Riding Through Water

WARNING

- * *Do not ford any stream with fast flowing water. The tires may float, making it difficult to maintain control.*
- * *Do not ride the vehicle through water for extended periods.*

The Honda ATC can ford water to a depth of approximately 300 mm (12 in.) although the rider must be careful to avoid getting the spark plug or air cleaner wet from splashing water.

When crossing streams, choose a course where both banks have gradual inclines. Proceed at a slow, steady speed, and take care to avoid submerged obstacles and slippery rocks.

After riding through water, the brakes may be less effective than normal. Test the brakes after traveling through any water, and if necessary, apply the brakes repeatedly until the heat of friction has dried them, and the brakes regain their normal effectiveness.



High Altitude Riding

When operating this vehicle at high altitudes the air-fuel mixture becomes overly rich. Above 6,500 feet (2,000 m) driveability and performance may be reduced and fuel consumption increased. The carburetor can be modified to compensate for this high altitude richness. However, the carburetor must be returned to standard factory specifications when lower altitude riding is desired. (See pages 45-47).

PARKING

1. Stop the vehicle, shift the transmission into low and turn the fuel valve and engine stop switch OFF.
2. Apply the parking brake by pulling in the clutch lever and locking it with the lock.

CAUTION:

- * *To start the engine on a slope, apply the parking brake, shift into neutral and then operate the kick-starter pedal.*



- * *Do not park on an incline. If you must park on a hill, place the ATC transversely across the incline.*

MAINTENANCE

MAINTENANCE SCHEDULE

- The maintenance intervals shown in the following schedule are based upon average riding conditions. ATCs subjected to severe use, or ridden in unusually dusty areas, require more frequent servicing.
- The U.S. Environmental Protection Agency requires manufacturers to certify that vehicles built after January 1, 1983 comply with applicable noise emission standards for one year or 3,000 km (1,865 miles) after the time of sale to the ultimate purchaser, when operated and maintained according to the instructions provided. Compliance with the terms of the Distributor's Warranty for the Honda Vehicle Noise Emission Control System is necessary in order to keep the noise emission control system in effect. (USA only)

I: Inspect and Clean, Adjust, Lubricate or Replace, if necessary C: Clean R: Replace L: Lubricate A: Adjust		INITIAL SERVICE PERIOD (First week of operation)	REGULAR SERVICE PERIOD (Every 30 operating days)	Refer to page
	EVERY			
*	FUEL LINE	YEAR: I		41
*	FUEL STRAINER SCREEN	YEAR: C		41
*	THROTTLE OPERATION		I	55
	AIR CLEANER	NOTE (1)		48
	AIR CLEANER CASE DRAIN TUBE	NOTE (2)		46
	SPARK PLUG		I	47
*	VALVE CLEARANCE		I	42

* SHOULD BE SERVICED BY AN AUTHORIZED HONDA DEALER, UNLESS THE OWNER HAS PROPER TOOLS AND IS MECHANICALLY QUALIFIED.

** IN THE INTEREST OF SAFETY, WE RECOMMEND THESE ITEMS BE SERVICED ONLY BY AN AUTHORIZED HONDA DEALER.

I: Inspect and Clean, Adjust, Lubricate or Replace, if necessary C: Clean R: Replace L: Lubricate A: Adjust		EVERY	INITIAL SERVICE PERIOD (First week of operation)	REGULAR SERVICE PERIOD (Every 30 operating days)	Refer to page
	ENGINE OIL		R	R	38
*	ENGINE OIL STRAINER SCREEN			C	39
*	ENGINE OIL CENTRIFUGE FILTER			C	40
*	CARBURETOR IDLE SPEED		I	I	44
	DRIVE CHAIN	NOTE (1), (2)	I, L	I, L	56
	DRIVE CHAIN SLIDER AND ROLLER			I	57
	BRAKE FLUID	2 YEARS: R, I	I	I	51
*	BRAKE PAD WEAR	YEAR: I NOTE (1), (2)			53
	BRAKE SYSTEM		I	I	51
*	CLUTCH SYSTEM		I	I	49
*	SUSPENSION			I	—
*	SPARK ARRESTER	NOTE (3)		C	58
*	NUT, BOLT, FASTENER		I	I	—
**	WHEEL		I	I	15
**	STEERING HEAD BEARING	YEAR: I			—

NOTES: (1) Service more frequently when riding in dusty areas, sand or snow.
(2) Service more frequently after riding in very wet or muddy conditions.
(3) USA only.

WARNING

- * *Always turn the engine off before performing any maintenance operations unless otherwise stated.*
 - * *To maintain the safety and reliability of your HONDA ATC, do not modify it and use only new genuine HONDA parts or their equivalent when servicing or repairing.*
- The use of replacement parts which are not of equivalent quality may impair the operation of your ATC.*

TOOL KIT

The tool compartment (1) is mounted on the left side below the rear fender on the rear grip pipe. The tools provided are sufficient to perform routine maintenance and simple repairs. Any extensive work requiring additional tools should be performed by an authorized Honda motorcycle dealer.

- 17 mm box end wrench
- Screw driver
- Grip for screw driver
- 10 x 12 mm open end wrench
- Pliers
- Handle bar A
- 120 mm handle
- 12 x 14 mm open end wrench
- 18 mm box wrench

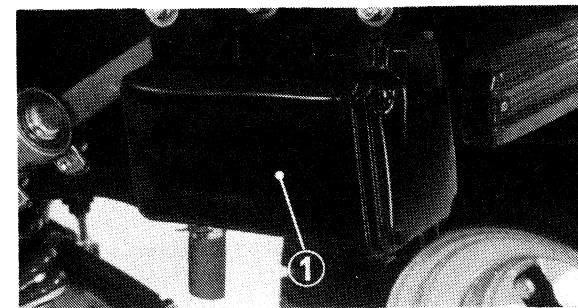

ENGINE OIL

Engine oil should be changed in accordance with the maintenance schedule. Use motor oils of the grade and viscosity recommended on page 15.

When changing oil, drain the oil from the crankcase while the engine is still warm. This will ensure complete and rapid draining.

1. Remove the oil filler cap from the right crankcase cover.
2. Place a drip pan under the engine to catch the oil, and then remove the drain plug (1) with a 17 mm box end wrench.
3. After the oil stops draining, turn the engine stop switch OFF and kick the kickstarter pedal several times to drain any oil which may be left in the engine.
4. When the oil has been completely drained, check that the drain plug sealing washer is in good condition and install the drain plug.
5. Fill the crankcase with approximately 1.5 ℓ (1.6 US qt) of the recommended grade of motor oil.
6. Make sure that the oil level is between the upper and lower level marks on the dipstick. If necessary, add more oil but do not overfill.

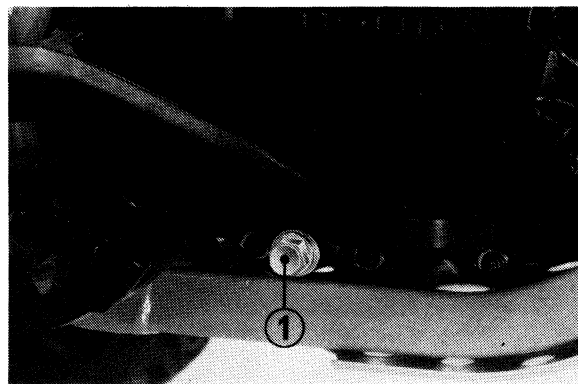

(1) Drain plug

ENGINE OIL STRAINER SCREEN

The oil filter screen should be cleaned in accordance with the Maintenance Schedule on page 35.

1. Drain the engine oil.
2. Remove the right footpeg (1), kickstarter pedal (2) and rear brake pedal (3).
3. Disconnect the clutch cable (4).
4. Remove the right crankcase cover (5).
5. Remove the oil strainer screen (6) from the crankcase.
6. Clean the oil strainer screen.

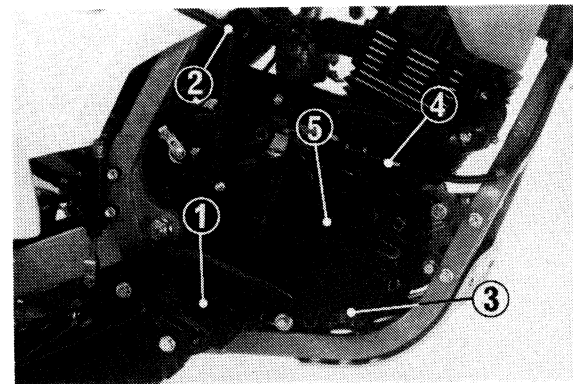

(1) Footpeg (2) Kickstarter pedal (3) Rear brake pedal (4) Clutch cable (5) Right crankcase cover (6) Oil strainer screen

Installation

- Reinstall the oil strainer screen by reversing the disassembly sequence.
- Tighten the right crankcase cover bolts to 7–11 N·m (0.7–1.1 kg·m, 5–8 ft·lb) torque.

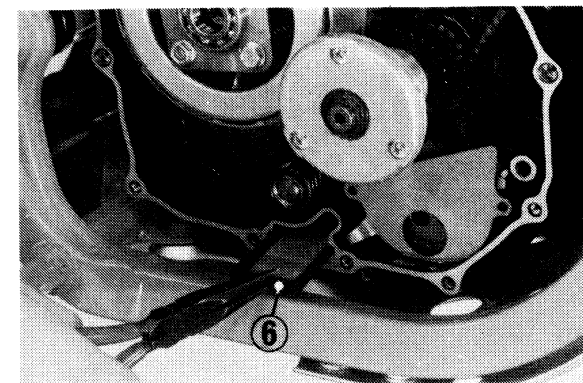

(5) Right crankcase cover (6) Oil strainer screen

OIL FILTER ROTOR

The oil filter rotor should be cleaned in accordance with the Maintenance Schedule on page 35.

1. Remove the right crankcase cover (page 39).
2. Remove the oil filter rotor cover (1) and clean the oil filter rotor (2).
3. Make sure the rotor cover gasket is in good condition and reinstall the oil filter rotor cover.

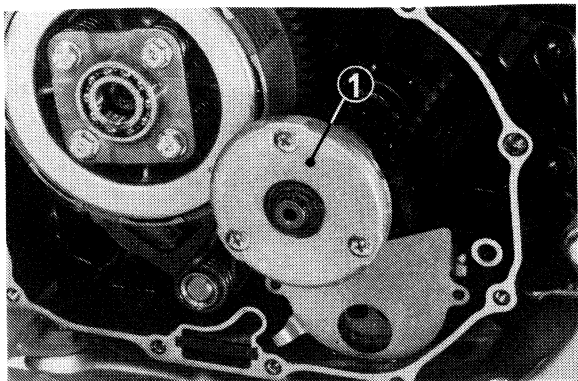

(1) Oil filter rotor cover

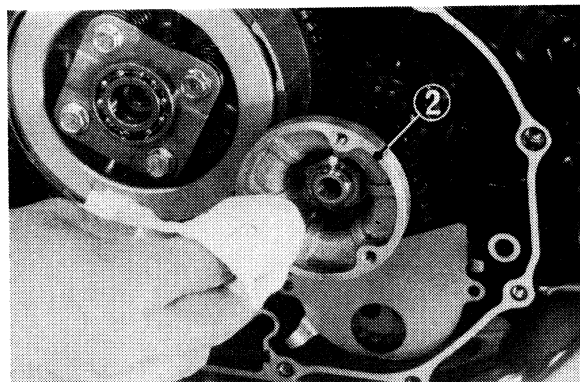

(2) Oil filter rotor

4. Install the other parts in the reverse order of removal.
5. Adjust the clutch's free play.
6. Fill the crankcase with the recommended oil and check for oil leaks.

FUEL STRAINER SCREEN

The fuel strainer is also incorporated in the fuel valve. The fine mesh screen of the strainer prevents dirt from entering the carburetor passages. Dirt which accumulates in the fuel strainer must be removed periodically, or the fuel flow will eventually be restricted.

WARNING

** Gasoline is extremely flammable and is explosive under certain conditions. Perform this operation in a well-ventilated area with the engine stopped. Do not smoke or allow flames or sparks in the area.*

1. Turn the fuel valve OFF.
2. Remove the strainer cap.
3. Remove the strainer screen (1).
4. Wash the screen in non-flammable or high flash point solvent.

WARNING

** Never use gasoline or low-flash point solvents for cleaning the fuel strainer. A fire or explosion could result.*

5. Reassemble by reversing the disassembly sequence.
6. Turn the fuel valve ON, and check for leaks. Correct if necessary.

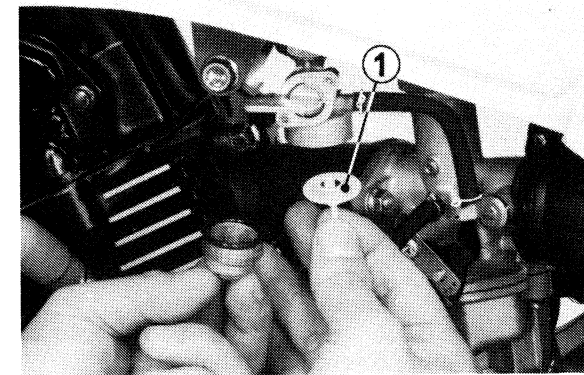

(1) Strainer screen

VALVE CLEARANCE

Valve clearance should be maintained properly. Excessive clearance will cause noise. Insufficient clearance will cause loss of power and could cause valve damage. If the valves are noisy, or if the engine lacks power, adjust the valve clearance as follows.

NOTE:

* Check and adjust valve clearance while the engine is cold. The clearance will change as the temperature rises.

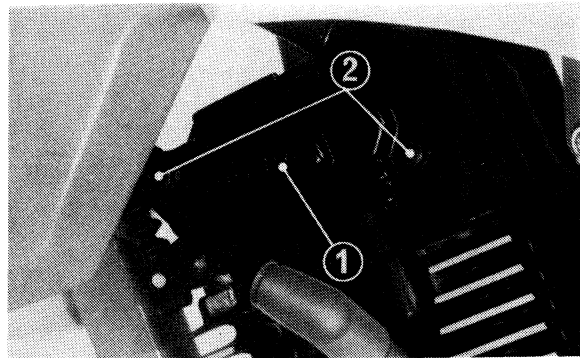

(1) Valve adjuster cover (2) Bolts

1. Remove the valve adjuster cover (1) from the left side of the cylinder head cover by removing the two bolts (2).
2. Remove the timing indicator hole cap (3) between the intake adjuster (4) and the exhaust adjuster (5).
3. Remove the timing mark hole cap (7) and the alternator cap (8).

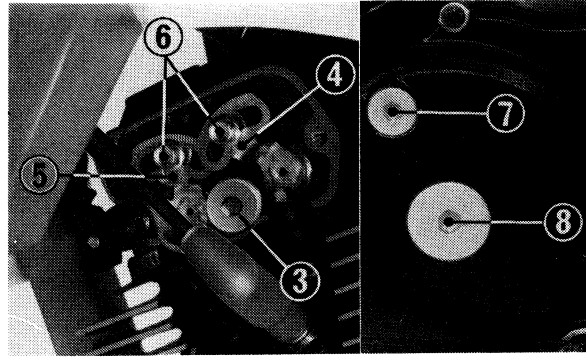

(3) Indicator hole cap (6) Lock bolts
(4) Intake adjuster (7) Timing mark hole cap
(5) Exhaust adjuster (8) Alternator cap

4. Using a socket on the alternator center bolt, rotate the alternator rotor counterclockwise until the "T" mark (10) on the alternator rotor aligns with the timing index mark (11) on the left crankcase cover. Make sure the arrow (9) on the camshaft is visible through the timing indicator hole. If the arrow is not visible, rotate the alternator rotor 360° (one complete revolution) and realign the "T" mark. Verify that the arrow is now visible.
5. Loosen the valve adjuster lock bolts (6).
6. Move the intake and exhaust adjusters counterclockwise until you feel slight resistance.

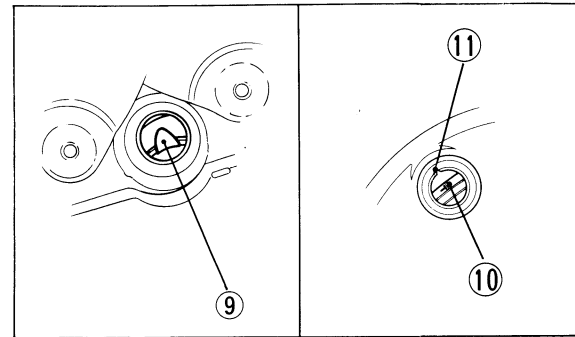

(9) Arrow mark (10) T mark
(11) Timing index mark

7. Return the adjusters 1 graduation clockwise on the adjuster plate and tighten the lock bolts securely.

NOTE:

- * Make sure the adjusters do not move when tightening the lock bolts.
 - * Half of a graduation is equal to 0.08 mm (0.003 in), which is the specified valve clearance.
8. Reinstall the removed parts in the reverse order of removal.

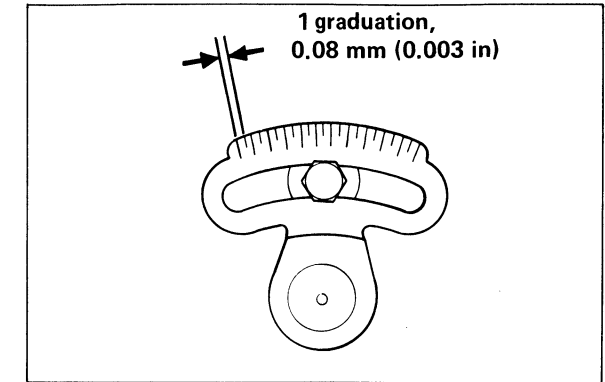

CARBURETOR IDLE SPEED

The engine must be warm for accurate idle adjustment. Ten minutes of stop-and-go riding is sufficient.

NOTE:

* Do not attempt to compensate for faults in other systems by carburetor adjustment. See your authorized Honda dealer for regularly scheduled carburetor adjustments.

To adjust the carburetor:

1. Warm up the engine.
2. Adjust idle speed with the throttle stop screw (1). IDLE SPEED: 1,400 ± 100 rpm
3. Adjust the fuel mixture by turning the pilot screw (2) clockwise until you hear the engine miss or decrease in speed, then counterclockwise until the engine again misses or decreases in speed. Center the pilot screw exactly between these two extreme positions.

Usually the correct setting (between extremes of rich and lean) will be found to be 1-1/2 turns open from a fully closed position.

If idle speed changes after adjusting the fuel mixture, readjust the throttle stop screw.

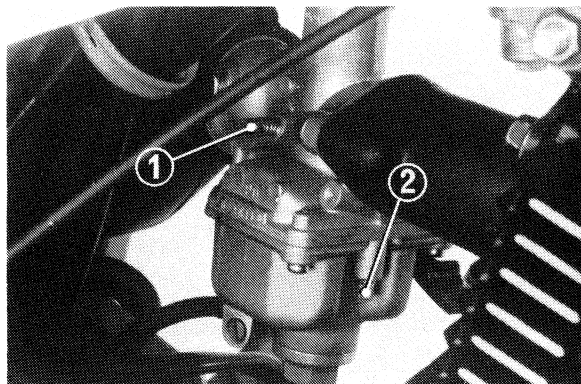

(1) Throttle stop screw (2) Pilot screw

HIGH ALTITUDE

When operating the ATC at high altitude the air-fuel mixture becomes overly rich.

Above 6,500 feet (2,000m) driveability and performance may be reduced and fuel consumption increased.

A high altitude jet is available for carburetor modification to compensate for this high altitude richness. Although installation and adjustment procedures are offered here, we strongly urge that the carburetor modifications, installation and adjustment procedures given here be performed by your authorized Honda dealer, unless you are mechanically proficient and have the necessary tools.

CAUTION:

* Sustained operation at lower altitudes below 5,000 feet (1,500 m) with the high altitude jet installed may cause engine overheating and damage.

Altitude	Main jet	Pilot screw
Below 6,500 feet	No. 112	Factory preset
Above 5,000 feet	No. 108	1/4 screw in

Installation:

1. Turn the fuel valve OFF.
2. Place the carburetor drain tube into a suitable container. Turn the carburetor drain screw counterclockwise and drain the carburetor.

WARNING

* Gasoline is extremely flammable and is explosive under certain conditions. Perform this operation in a well ventilated area. Do not smoke or allow flames or sparks in the area.

3. Remove the drain bolt.

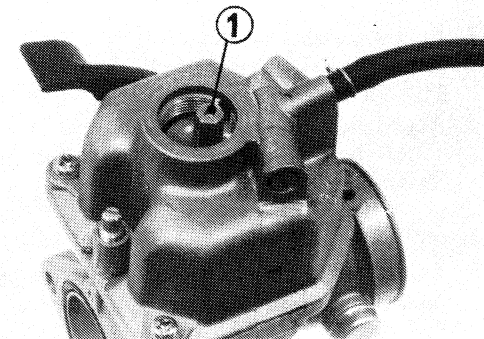

(1) Main jet

- Remove the standard main jet (No. 112) (1) and install the high altitude main jet (No. 108). Reinstall the float chamber.
- Make sure the drain screw is turned fully clockwise and turn the fuel valve ON.
- Check to see if the throttle returns without hesitation and the throttle valve comes down to the lowest position without fail.
- Make sure that the fuel tube and overflow tube are correctly routed as they were originally installed.
- Start the engine. Adjust the idle speed and fuel mixture.

Removal:

- Follow installation steps 1–3.
- Reinstall the original No. 112 main jet. Tighten and torque the carburetor drain bolt.
- Adjust the idle speed with the throttle stop screw; adjust the fuel mixture with the pilot screw (page 44).

NOTE:

- * Adjust the idle speed and fuel mixture at low altitude to ensure proper low altitude operation.

AIR CLEANER CASE DRAIN TUBE

- Remove the drain tube (1) and drain the deposits.
- Reinstall the drain tube.

NOTE:

- * Service more frequently when deposits can be seen in the drain tube.

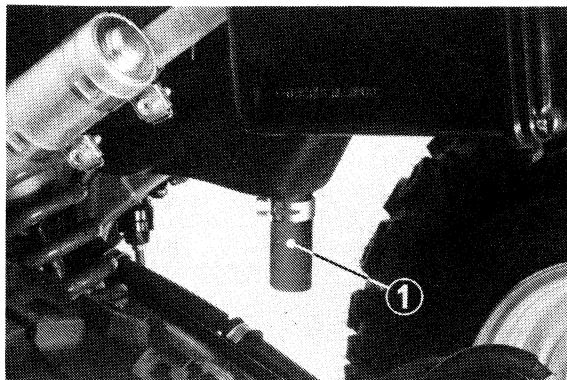

(1) Drain tube

SPARK PLUG

NGK: DR8ES-L
ND: X24ESR-U

CAUTION:

- * *The use of spark plugs of incorrect size or heat range can cause serious engine damage.*

- Clean any dirt from around the spark plug base.
- Disconnect the spark plug cap and remove the plug with the wrench provided in the tool kit.
- Visually inspect the spark plug electrodes for wear. The center electrode should have square edges and the side electrode should not be eroded. If the electrodes and insulator tip appear unusually fouled or burned, we suggest that you contact an authorized Honda dealer to determine the cause of this condition. Discard the spark plug if there is apparent wear or if the insulator is cracked or chipped.
- Make sure that the spark plug gap is 0.6–0.7 mm (0.024–0.028 in) using a wire-type feeler gauge. If adjustment is necessary, bend the side electrode (1) carefully.

- With the plug washer attached, thread the spark plug in by hand to prevent **cross-threading**.
- Tighten a new spark plug ½ turn with a spark plug wrench to compress the washer. If you are reusing a plug, it should only take 1/8–1/4 turn after the plug seats.

CAUTION:

- * *The spark plug must be securely tightened. An improperly tightened plug can become very hot and possibly damage the engine.*

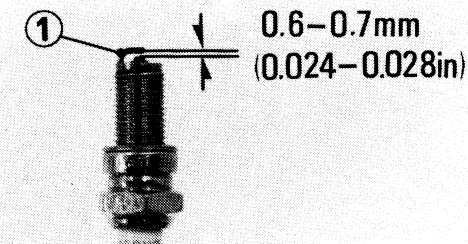

(1) Side electrode

AIR CLEANER

The air cleaner element accumulates dust and must be cleaned periodically. If the ATC200X is ridden in unusually dusty areas, the element must be cleaned at more frequent intervals than specified in the MAINTENANCE SCHEDULE.

1. Remove the seat/rear fender by sliding the lever (1).
2. Remove the air cleaner cover (2) by removing the four clips (3).
3. Remove a screw attaching the air cleaner element holder (4) and remove air cleaner element (5).



(1) Lever
(2) Air cleaner cover
(3) Clips

4. Wash the air cleaner element (5) in clean non-flammable or high flash point solvent. Allow it to dry thoroughly.

WARNING

* *Never use gasoline or low flash point solvents for cleaning the air cleaner element. A fire or explosion could result.*

5. Soak the filter element in clean gear oil (SAE 80–SAE 90) until saturated, then squeeze out the excess oil.
6. Reassemble by reversing the disassembly sequence.

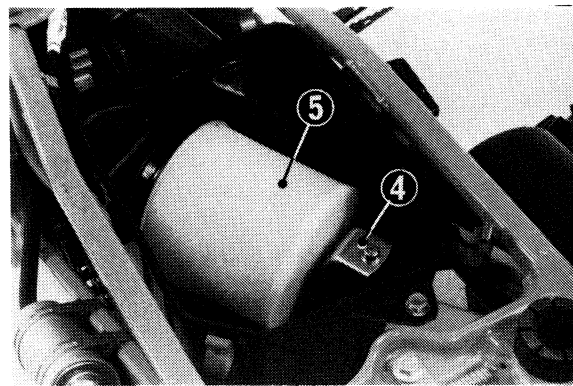

(4) Air cleaner element holder
(5) Air cleaner element

CLUTCH SYSTEM

Clutch adjustment may be required if the ATC stalls when shifting into gear or tends to creep; or if the clutch slips, causing acceleration to lag behind engine speed.

Normal clutch lever free play is 10–20 mm (3/8–3/4 in) at the lever (1).

Minor adjustments can be made with the clutch cable adjuster (2) at the lever (1).

1. Loosen the lock nut (3) and turn the clutch cable adjuster (2). Tighten the lock nut (3) and check the adjustment.

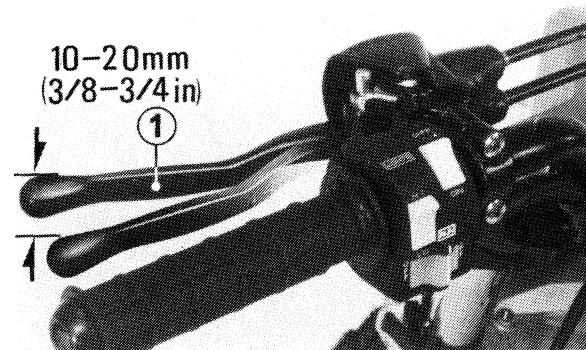

(1) Clutch lever

2. If the adjuster is threaded out near its limit or the correct free play cannot be obtained using the cable adjuster (2), a major adjustment must be made. Loosen the lock nut (3) and turn in the adjuster (2) completely (B). Tighten the lock nut (3).

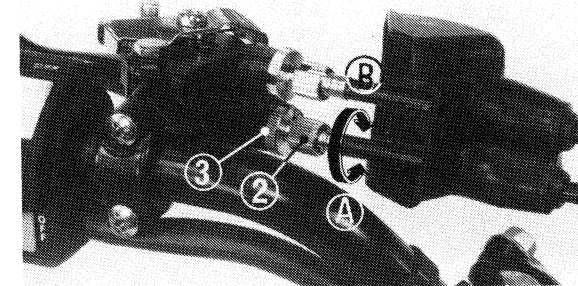

(2) Clutch cable adjuster
(3) Lock nut
(A) Decrease free play
(B) Increase free play

3. At the lower end of the cable, loosen the lock nut (4). Turn the adjusting nut (5) to obtain the specified free play at the clutch lever. Tighten the lock nut (4) and check the adjustment.
4. Start the engine, pull in the clutch lever and shift into gear. Make sure the engine does not stall, and the ATC does not creep. Gradually release the clutch lever and open the throttle. The ATC should start smoothly and accelerate gradually.

NOTE:

* If proper adjustment cannot be obtained or the clutch does not work correctly, the cable or clutch friction discs may be worn. Refer to the official Honda shop manual or see your authorized Honda dealer.

Other Checks:

Check the clutch cable for kinks or signs of wear that could cause sticking or failure. Lubricate the clutch cable with a commercially available cable lubricant to prevent premature wear and corrosion.

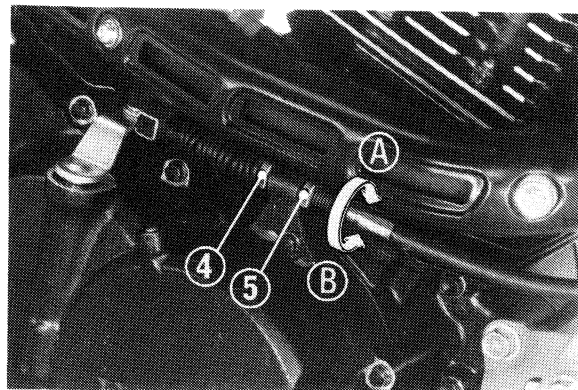

(4) Lock nut (A) Decrease free play
 (5) Adjusting nut (B) Increase free play

BRAKES

Both front and rear brakes are hydraulic disc types. As the brake pads wear, brake fluid level drops, automatically compensating for wear. There are no adjustments to perform, but fluid level and pad wear must be inspected periodically. The system must be inspected frequently to ensure there are no fluid leaks.

NOTE:

* If the brake lever or pedal travel become excessive and the brake pads are not worn beyond the recommended limit (page 53), there is probably air in the brake system and it must be bled. See your authorized Honda dealer for this service.

WARNING

* Brake fluid may cause irritation. Avoid contact with skin or eyes. In case of contact, flush thoroughly with water and call a doctor if your eyes were exposed.

Front Brake Fluid Level:

Remove the screws, reservoir cap and diaphragm. Whenever the level is near the lower level mark (2), fill the reservoir with DOT 3 or 4 BRAKE FLUID from a sealed container, up to the upper level mark (1). Reinstall the diaphragm and reservoir cap. Tighten the screws securely.

CAUTION:

* When adding brake fluid, be sure the reservoir is horizontal before the cap is removed or brake fluid may spill out.

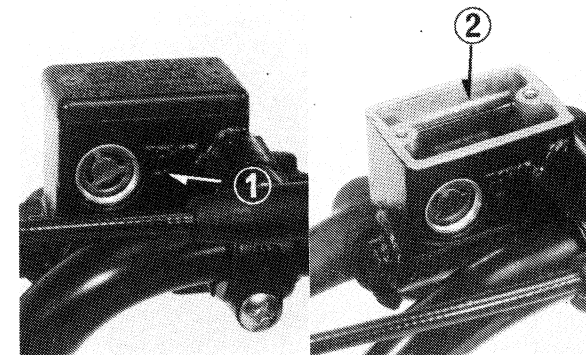

(FRONT) (1) Lower level mark
 (2) Upper level mark

CAUTION:

- * Use only DOT 3 or 4 brake fluid from a sealed container.
- * Handle brake fluid with care because it can damage paint.
- * Never allow contaminants (dirt, water, etc.) to enter the brake fluid reservoir.

Rear Brake Fluid Level:

Remove the reservoir cap and diaphragm. Whenever the level is near the lower level mark (4) on the rear reservoir, fill the reservoir with DOT 3 or 4 BRAKE FLUID from a sealed container, up to the upper level mark (3). Reinstall the diaphragm, and tighten the reservoir cap securely.

CAUTION:

- * Use only DOT 3 or 4 brake fluid from a sealed container.
- * Handle brake fluid with care because it can damage paint.
- * Never allow contaminants (dirt, water, etc.) to enter the brake fluid reservoir.

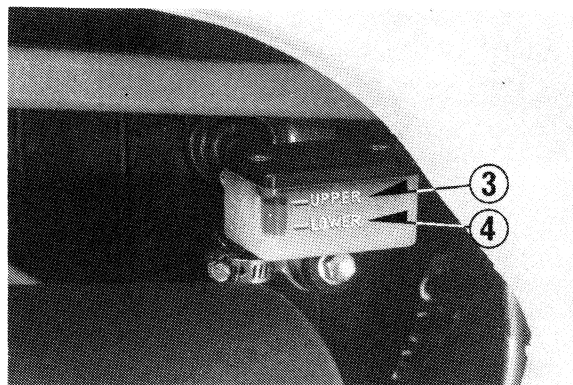

(REAR) (3) Upper level mark
(4) Lower level mark

Brake Pads:

Brake pad wear will depend upon the severity of usage and riding conditions. The pads will wear faster in wet or muddy conditions. Inspect the pads visually during all regular service intervals to determine the pad wear. If either pad wears to the wear indicator (1), both pads must be replaced. See your authorized Honda dealer for this service.

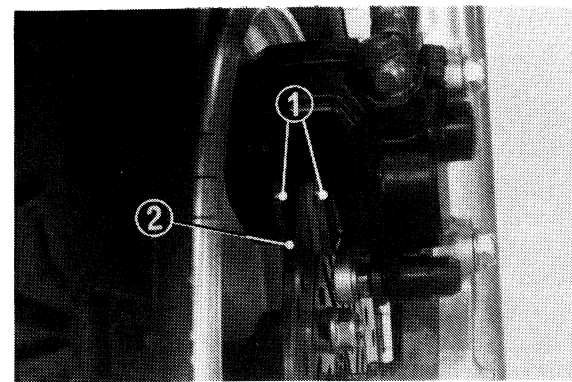

(1) Wear indicator (2) Brake disc

Other Checks:

Make sure there are no fluid leaks. Check for deterioration or cracks in the hose and fittings.

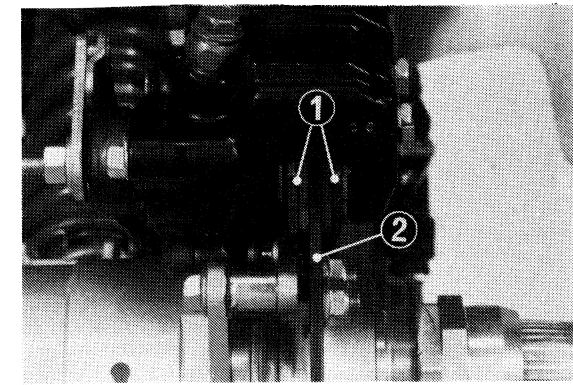

(1) Wear indicator (2) Brake disc

Parking brake

Parking brake adjustment may be required if the parking brake does not hold properly.

Parking Brake Adjustment

1. Loosen the lock nut (1) on the rear caliper.
2. Screw the adjusting bolt (2) in until you feel resistance without applying the clutch/parking brake lever, and tighten the lock nut (1).
3. Measure the distance of the parking brake arm (3). The arm free play should be 3.5–4.5mm (0.14–0.18 in) at the tip of the parking brake arm.

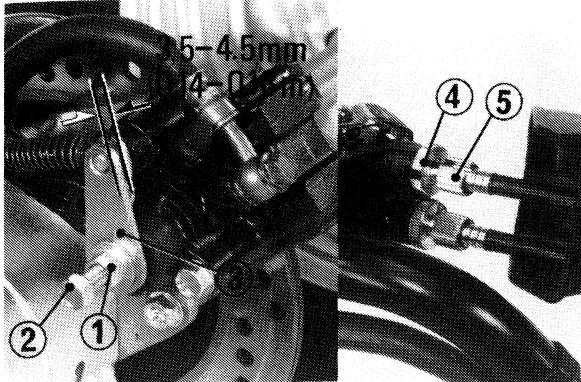

- (1) Lock nut
(2) Adjusting bolt
(3) Parking brake arm
(4) Lock nut
(5) Adjusting nut

4. Push down the parking brake pin (6) and squeeze the clutch lever until firm resistance is felt. Measure the distance the clutch lever has moved; the distance should be 31–39 mm (1.2–1.5 in).
5. To adjust the distance, loosen the lock nut (4) and turn the adjuster (5).
6. Recheck the distance of the parking brake arm (3) free play.

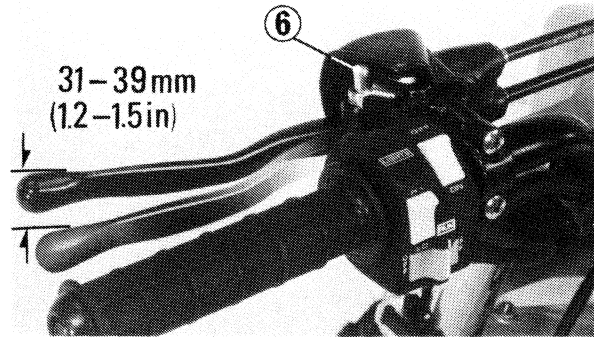

- (6) Parking brake pin

THROTTLE OPERATION

Inspect throttle cable condition and operation. The cable must not bind or impair smooth operation of the throttle lever in any steering position. Replace the cable if it has become worn or kinked. Lubricate the cable with a commercially available cable lubricant to prevent premature wear and corrosion.

Free play, measured from the forward edge of the throttle lever (1) should be maintained at 3–8 mm (0.12–0.31 in). The cable adjuster (3) is located near the throttle lever. Loosen the lock nut (2) and turn the adjuster to obtain the correct free play.

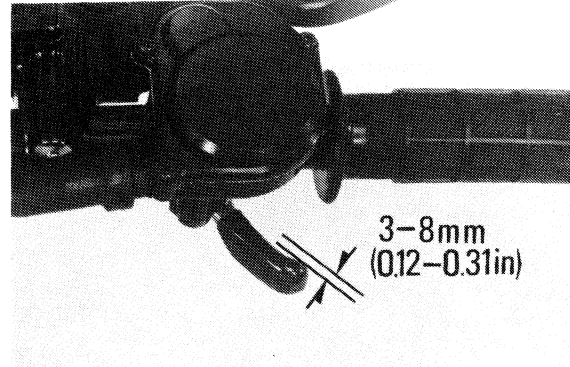

- (1) Throttle lever

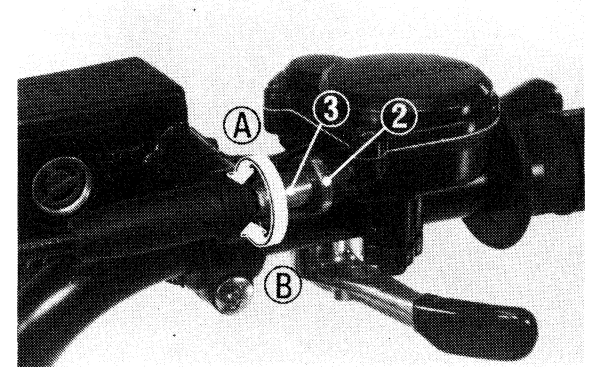

- (2) Lock nut
(3) Cable adjuster
(A) Decrease free play
(B) Increase free play

DRIVE CHAIN

The drive chain (1) will wear with use and requires periodic adjustment in accordance with the maintenance schedule.

NOTE:

* Check, adjust or lubricate the chain with the engine off.

Chain slack should be checked by measuring the amount of chain slack midway between the sprockets. The amount of slack should be 25–35 mm (1.0–1.4 in).

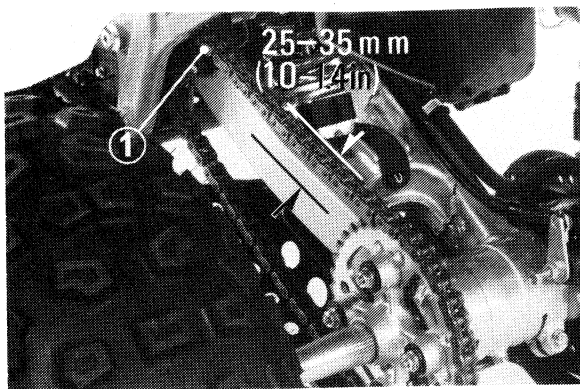

(1) Drive chain

To adjust slack, loosen two lock bolts (2). Turn the adjuster (4) to decrease or increase chain slack using the allen wrench (3). After adjusting the chain slack 25–35 mm (1.0–1.4 in), retighten the lock bolts. Measure a section of the drive chain to determine whether the chain is worn beyond its service limit. Remove the drive chain and measure the distance between a span of 85 pins from pin center to pin center. In a new chain, this distance will measure 1,349 mm (53.1 in). If the distance exceeds 1,356 mm (53.4 in), the chain is worn out and should be replaced.

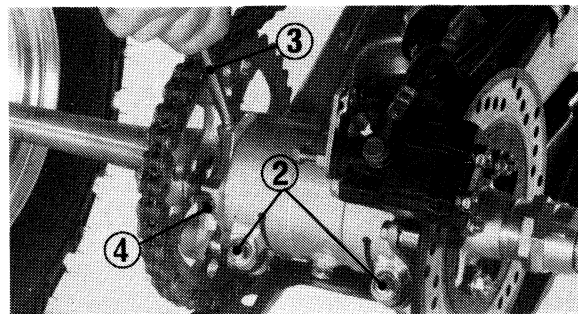
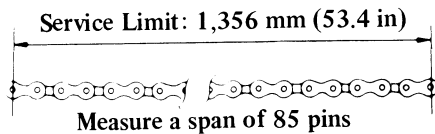

(2) Lock bolts
(3) Provided tool

(4) Adjuster

Lubrication and cleaning:

Lubricate every 30 days of riding or sooner if chain appears dry. The O-rings in this chain can be damaged by steam cleaning, high pressure washers, and certain solvents.

Clean the chain with kerosene. Wipe dry and lubricate only with SAE 80 or 90 gear oil. Commercial chain lubricants may contain solvents which could damage the rubber O-rings.

Drive Chain Slider

Check the drive chain slider at the intervals specified in the Maintenance Schedule.

When the depth of the grooves in the slider reaches 2.0 mm (0.08 in), remove material to lower the height of the center ridge between the grooves to less than 2.0 mm (0.08 in).

Replace the slider when the depth of the grooves reaches 6.0 mm (0.24 in).

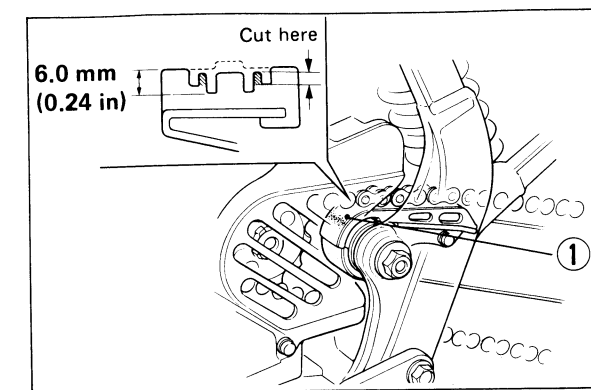

(1) Chain slider

SPARK ARRESTER

The exhaust system must be periodically purged of accumulated carbon.

To remove carbon:

1. Remove the spark arrester fasteners (1) and spark arrester plate (2).

WARNING

- * *Do not perform this operation immediately after the engine has been run because the exhaust system becomes very hot.*
 - * *Because of the increased fire hazard ensure that there are no combustible materials in the area when purging the spark arrester.*
 - * *Wear eye protection.*
 - * *Do not stand behind the vehicle while purging the carbon from the spark arrester.*
 - * *Never run the engine in a closed area. The exhaust contains poisonous carbon monoxide gas.*
2. Start the engine, and purge accumulated carbon from the system by momentarily revving up the engine several times.
 3. Stop the engine and allow the exhaust pipe to cool.
 4. Reinstall the spark arrester plate.

CAUTION:

- * *The two mounting screws (3) must be installed in the spark arrester body at all times for the spark arrester to be effective.*

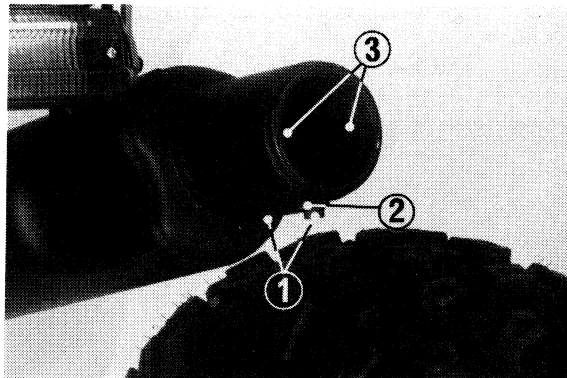

(1) Spark arrester fasteners (3) Screws
(2) Spark arrester plate

STORAGE

To prepare the ATC for storage:

1. Completely clean all parts of the ATC. If the ATC has been exposed to sea air or salt water, wash it down with fresh water and wipe dry.
2. Drain the fuel tank and carburetors. Spray the inside of the tank with an aerosol rust-inhibiting oil. Reinstall the fuel cap on the tank.
Turn the fuel valve to RES and remove the carburetor drain screw; drain gasoline into an approved container. Reinstall the drain screw.

WARNING

- * *Gasoline is flammable and is explosive under certain conditions. Do not smoke or allow flames or sparks near the equipment while draining fuel.*
3. Inflate the tires to their normal pressure and place the ATC on blocks to raise the tires off the ground.
 4. Cover the ATC and store in a place which is free of humidity and dust.

Removal from Storage

1. Uncover and clean the ATC. Change the engine oil if more than 4 months have passed since the start of storage.
2. Drain any excess aerosol rust-inhibiting oil from the fuel tank. Fill the fuel tank with fresh gasoline.
3. Perform all Pre-ride Inspection checks (page 21).
Test ride the ATC at low speeds in a safe riding area away from traffic.

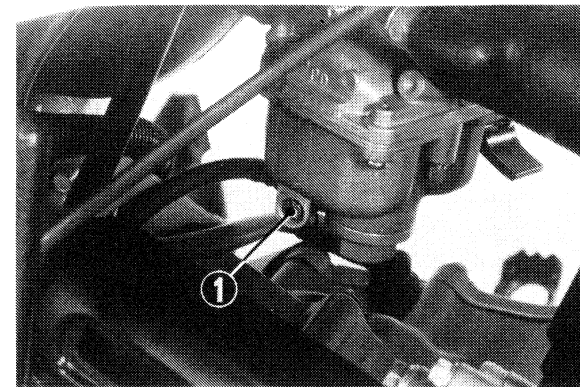

(1) Carburetor drain bolt

TRANSPORTING

1. Turn the fuel valve OFF.
2. Remove the drain screw from the carburetor and drain the gasoline into a suitable container.

WARNING

* *Never transport the machine on its side or with the front wheel straight up unless all fuel has been drained.*

3. Reinstall the drain screws.

NOTE:

- * Be sure the drain screw is tightened.
- * If wheel removal is required when transporting, follow the procedures on the following pages.

Front Wheel Removal

1. Place a support block under the engine to raise the front wheel off the ground.
2. Remove the four wheel hub nuts (1).
3. Remove the three nuts (2) securing the front disk plate (3).
4. Remove the two bolts (4) securing the front brake caliper (5).
5. Loosen the axle holder nuts (6) and remove the axle (7).
6. Remove the axle collar (8) and front wheel.

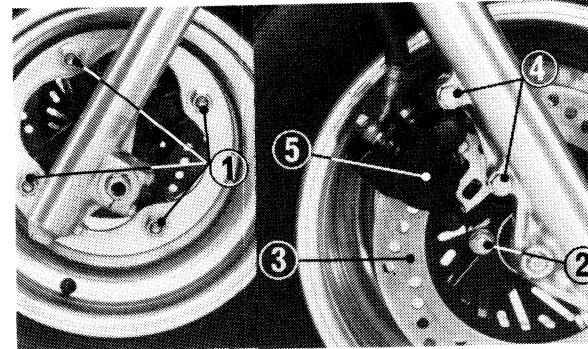

- | | |
|--------------------|-------------------------|
| (1) Wheel hub nuts | (3) Disk plate |
| (2) Nuts | (4) Bolts |
| | (5) Front brake caliper |

Installation

1. Install the axle holder with UP mark (9) facing upwards. Install the holder nuts (6). Do not tighten them at this time.
2. Install the front wheel and collar (8) and insert the front axle (7).
3. Tighten the axle to 70–110 N·m (7–11 kg·m, 51–80 ft·lb) torque.
4. Tighten the axle holder nuts (6) to 10–14 N·m (1.0–1.4 kg·m, 7.2–10 ft·lb) torque.
5. Install the front disk plate (5) and tighten it to 20–30 N·m (2.0–3.0 kg·m, 14–22 ft·lb) torque.
6. Install the front brake caliper (2) and tighten it to 20–30 N·m (2.0–3.0 kg·m, 14–22 ft·lb) torque.
7. Install the wheel hub nuts (1) and tighten them to 60–70 N·m (6.0–7.0 kg·m, 43–50 ft·lb).

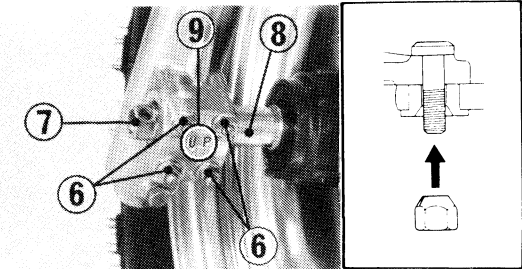

- | | |
|----------------------|-----------------|
| (6) Axle holder nuts | (8) Axle collar |
| (7) Axle | (9) UP mark |

WARNING

- * *When the front axle is reinstalled, be careful that the grease seal is not cut or damaged.*
- * *Be certain that the holding nuts and axle are tightened. If they are not, the wheel may come loose during operation.*
- * *If a torque wrench was not used for installation, see your authorized Honda dealer as soon as possible to verify proper assembly.*
- * *Install the wheel nuts with their tapers on the inside as shown.*

Rear Wheel Removal

1. Place a support block under the vehicle and raise the rear wheels off the ground.
2. Loosen the wheel nuts (1) with a 17 mm socket wrench.
3. Remove the wheel.

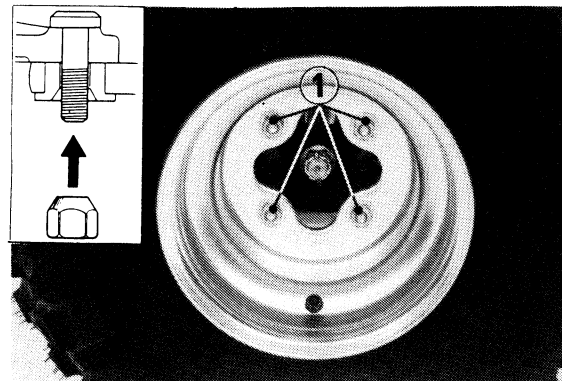

(1) Wheel nuts

Installation:

Reinstall the rear wheels with valve stems to the outside and tighten the wheel nuts (1) in a crisscross, torquing them to 30–40 N·m (3.0–4.0 kg·m, 22–29 ft·lb).

WARNING

- * *If a torque wrench was not used for installation, see your authorized Honda dealer as soon as possible to verify proper assembly.*
- * *Install the wheel nuts with their tapers on the inside as shown.*

NOISE EMISSION CONTROL SYSTEM(USA ONLY)

TAMPERING WITH THE NOISE CONTROL SYSTEM IS PROHIBITED: Federal law prohibits the following acts or the causing thereof: (1) The removal or rendering inoperative by any person, other than for purposes of maintenance, repair, or replacement, of any device or element of design incorporated into any new vehicle for the purpose of noise control prior to its sale or delivery to the ultimate purchaser or while it is in use; or (2) the use of the vehicle after such device or element of design has been removed or rendered inoperative by any person.

AMONG THOSE ACTS PRESUMED TO CONSTITUTE TAMPERING ARE THE ACTS LISTED BELOW:

1. Removal of, or puncturing the muffler, bafflers, header pipes or any other component which conducts exhaust gases.
2. Removal of, or puncturing of any part of the intake system.
3. Lack of proper maintenance.
4. Replacing any moving parts of the vehicle, or parts of the exhaust or intake system, with parts other than those specified by the manufacturer.

SPECIFICATIONS

DIMENSIONS	
Overall length	1860 mm (73.2 in)
Overall width	1080 mm (42.5 in)
Overall height	1050 mm (41.3 in)
Wheel base	1210 mm (47.6 in)
WEIGHT	
Dry weight	126.0 kg (278 lb)
CAPACITIES	
Engine oil	1.8 liter (1.9 US qt)
Fuel tank	10.5 liter (2.78 US gal)
Fuel reserve capacity	1.5 liter (0.40 US gal)
Passenger capacity	Operator only
ENGINE	
Bore and stroke	65 x 60 mm (2.56 x 2.36 in)
Compression ratio	9.5 : 1
Displacement	199 cc (12.14 cu in)
Spark plug gap	0.6 - 0.7 mm (0.024 - 0.028 in)

CHASSIS AND SUSPENSION	
Caster angle	21.5°
Trail length	30 mm (1.2 in)
Tire size	
Front	23.5 x 8-11
Rear	22 x 10.0-9
POWER TRANSMISSION	
Primary reduction	3.087
Final reduction	2.923
Gear ratio, 1st	3.455
2nd	2.333
3rd	1.778
4th	1.450
5th	1.227
6th	1.083

////////////////////// WIRING DIAGRAM ////////////////////////

MEMO

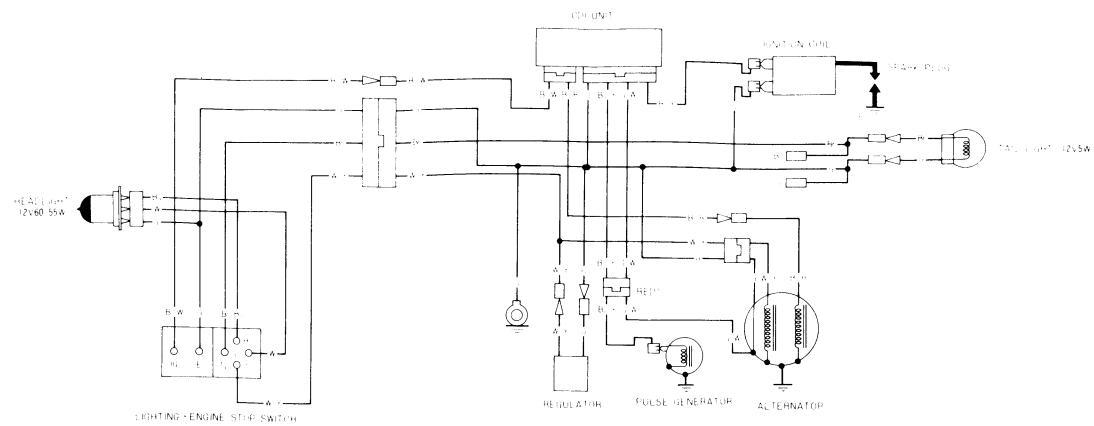

SWITCH CONTINUED

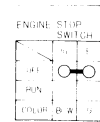
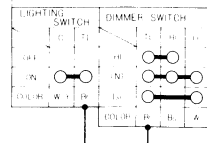

- B --- Black
- Y --- Yellow
- Bl --- Blue
- G --- Green
- R --- Red
- W --- White
- Br --- Brown
- O --- Orange
- Lb --- Light Blue
- Lg --- Light Green
- P --- Pink
- Gr --- Grey

0030Z-HB5-0000

WARRANTY SERVICE

Owner Satisfaction

Your satisfaction and goodwill are important to your dealer and to us. All Honda warranty details are explained in the Distributor's Limited Warranty. Normally, any problems with the product will be handled by your dealer's service department. Sometimes, however, in spite of the best intentions of all concerned, misunderstandings can occur. If your problem has not been handled to your satisfaction, we suggest you take the following action:

- Discuss your problem with a member of dealership management. Often complaints can be quickly resolved at that level. If the problem has already been reviewed with the Service Manager, contact the owner of the dealership or the General Manager.
- If your problem still has not been resolved to your satisfaction, contact the Customer Relations Department at the regional office of American Honda Motor Co., Inc. in your area. Regional office locations are shown on the following page. We will need the following information in order to assist you:
 - Your name, address, and telephone number
 - Product model and serial number
 - Date of purchase
 - Dealer name and address
 - Nature of the problem

After reviewing all the facts involved, you will be advised of what action can be taken. Please bear in mind that your problem will likely be resolved at the dealership, using the dealer's facilities, equipment, and personnel, so it is very important that your initial contact be with the dealer:

Your purchase of a Honda product is greatly appreciated by both the dealer and American Honda Motor Co., Inc. We want to assist you in every way possible to assure your complete satisfaction with your purchase.

Regional Office Locations

NORTHWEST REGIONAL OFFICE
(includes Alaska)
American Honda Motor Co., Inc.
Customer Relations Department
P.O. Box 30285
Portland, Oregon 97220
Telephone: (503) 255-1186

MIDWEST REGIONAL OFFICE
American Honda Motor Co., Inc.
Customer Relations Department
P.O. Box 22
Greendale, Wisconsin 53129
Telephone: (414) 421-9300

NORTHEAST REGIONAL OFFICE
American Honda Motor Co., Inc.
Customer Relations Department
P.O. Box 749
Moorestown, New Jersey 08067
Telephone: (609) 778-1100

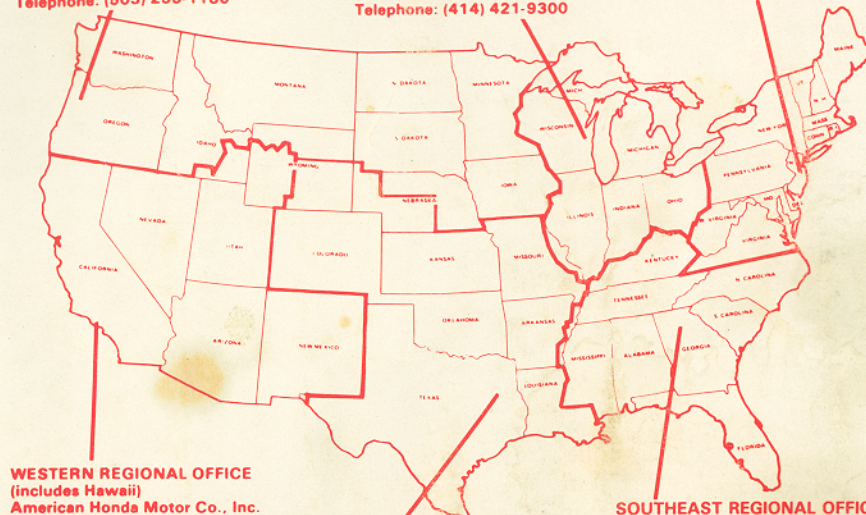

WESTERN REGIONAL OFFICE
(includes Hawaii)
American Honda Motor Co., Inc.
Customer Relations Department
P.O. Box 420
Gardena, California 90247
Telephone: (213) 604-2524

SOUTHWEST REGIONAL OFFICE
American Honda Motor Co., Inc.
Customer Relations Department
P.O. Box 5406
Irving, Texas 75062
Telephone: (214) 258-8883

SOUTHEAST REGIONAL OFFICE
(includes Puerto Rico)
American Honda Motor Co., Inc.
Customer Relations Department
1500 Morrison Parkway
Alpharetta, Georgia 30201
Telephone: (404) 442-2000